

*Williams*<sup>®</sup>

16P-496-100  
December, 1979

## SOLID STATE FLIPPER MAINTENANCE MANUAL

GORGAR, PRODUCTION  
LASER BALL, AND LATER GAMES

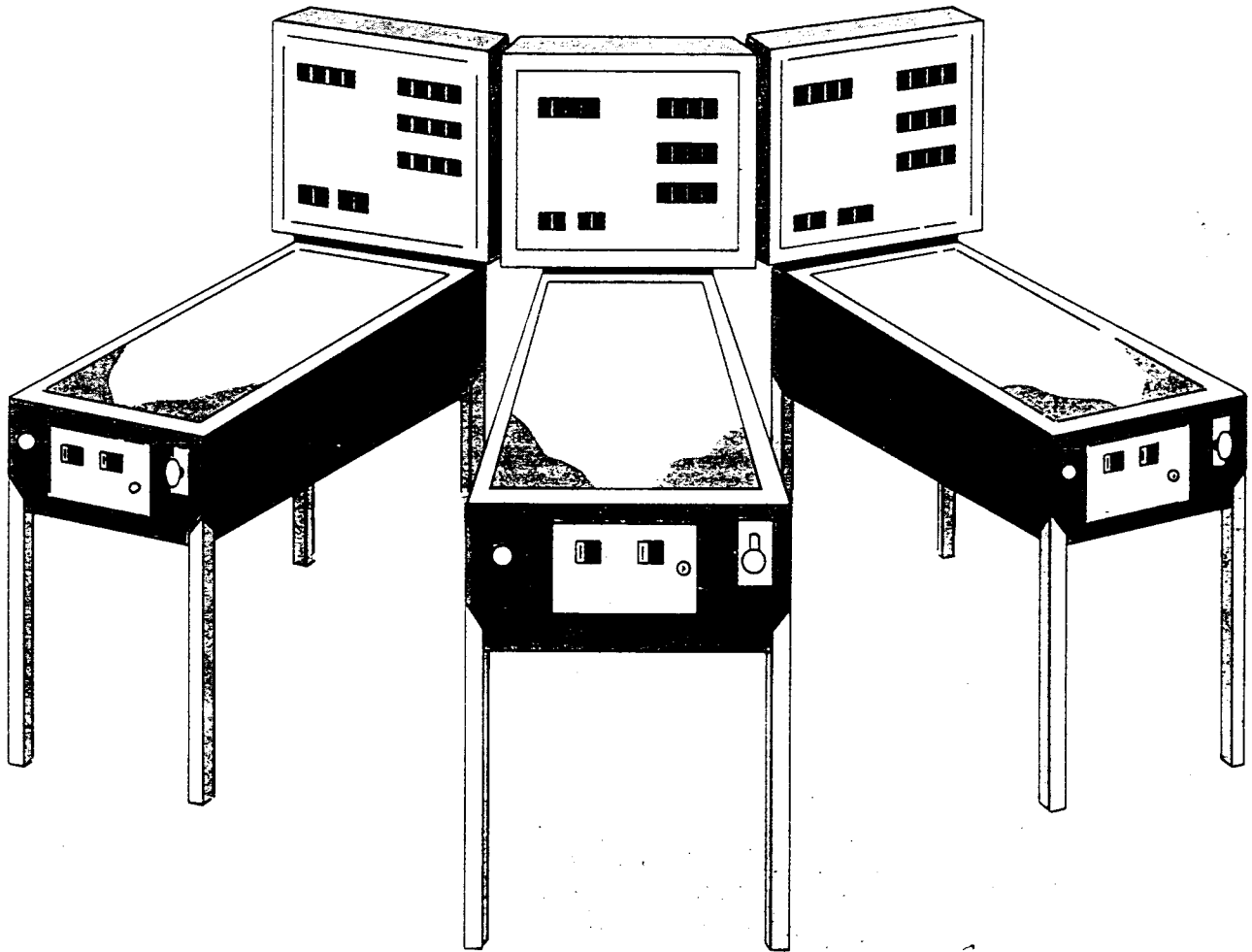

For service call TOLL-FREE:  
800-621-4765  
In Illinois Call:  
800-972-7898



*Williams*<sup>®</sup>  
**ELECTRONICS, INC.**

An Xcor International Inc., Company  
3401 N. California Ave., Chicago, IL 60618  
Cable Address: WILCOIN, CHICAGO  
(312) 267-2240

## FOREWORD

This instruction manual provides identification and mechanical adjustment, game adjustment, bookkeeping, diagnostic, and troubleshooting procedures; and general interconnection information for the latest solid state flipper games. Affected games include GORGAR and later conventional flippers and production LASER BALL and later wide-body flippers.

This manual is to be used in conjunction with the Instruction Booklet and Game Manual, both provided with the game.

The Instruction Booklet provides a quick reference for a description of game operation; game adjustment, bookkeeping and diagnostic procedures; and lamp, switch; and solenoid assignments. The booklet should be kept in the envelope provided on the cabinet just inside the coin door.

The Game Manual provides installation procedures, electrical and unique mechanical adjustments, unique maintenance information, and assembly and schematic diagrams.

## CONTENTS

Section	Page
1. IDENTIFICATION .....	2
Circuit Boards .....	2
Location of Major Assemblies .....	5
2. MECHANICAL MAINTENANCE .....	7
General Switch Blade Adjustments .....	7
Contact Care .....	7
Rollover Switch .....	7
Tilt Switch .....	7
Flipper Care .....	7
3. GAME ADJUSTMENTS .....	8
General Procedure .....	8
High Score to Date .....	8
Replay Scores .....	10
Maximum Credits .....	10
Game Pricing .....	10
High Score Credits .....	13
Match .....	13
Special .....	13
Scoring Awards .....	14
Maximum Plumb Bob Tilts .....	14
Number of Balls .....	14
Unique Game Adjustments .....	14
Restoring Factory Settings .....	15
4. BOOKKEEPING AND GAME EVALUATION ..	15
Feature Access .....	15
High Score Reset .....	16
Resetting Audit Totals .....	16
5. BUILT-IN DIAGNOSTICS .....	16
Display Digits Test .....	16
Lamp Test - Test 01 .....	16
Solenoid Test - Test 02 .....	17
Switch Test - Test 03 .....	17
Auto-Cycle Mode .....	17
6. MAINTENANCE .....	18
Board Replacement .....	18
CPU Board Self-Test .....	20
Sound Board and Speech Module Self-Tests .....	22
Sound Board Self-Test .....	22
Troubleshooting Charts .....	22
7. INTERCONNECTION CHARTS .....	28

### SECTION 1 IDENTIFICATION

#### Circuit Boards

- A Revision Level 6 CPU Board Required for Memory Protection Feature and for games that use game ROM and PROMs.
- B Revision Level 4 CPU Board Equipped

- With Three PROM Sockets and Game ROM Socket.
- C Revision Level 4 CPU Board Without Third PROM and Game ROM Sockets.
- D Revision Level 3 CPU Board.
- E Driver Board.
- F Power Supply Board.

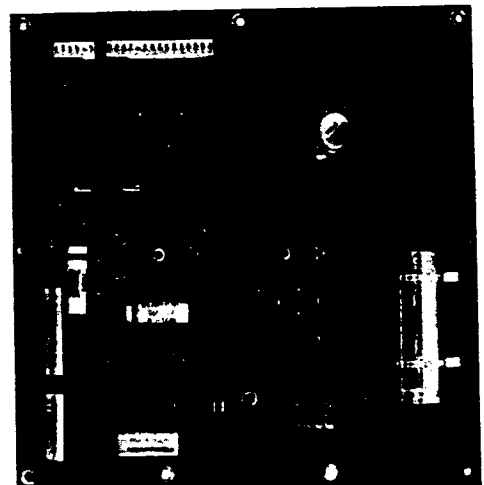
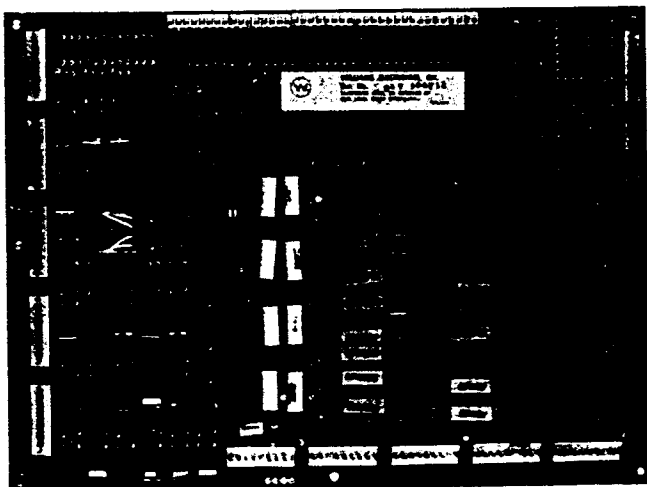
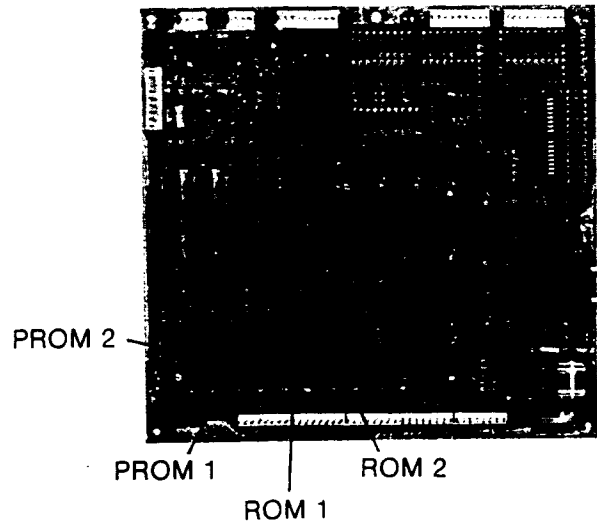
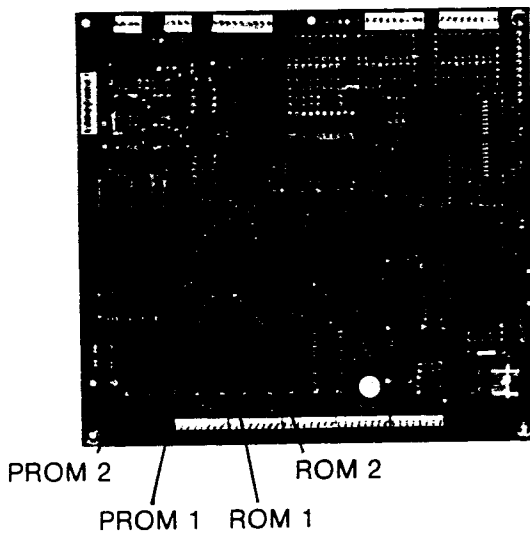
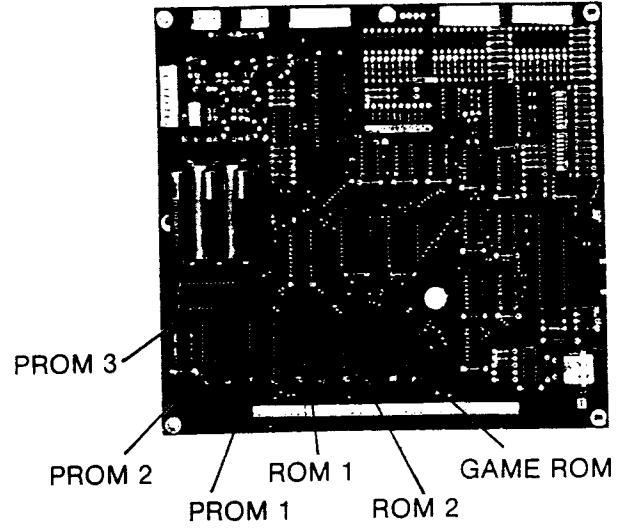
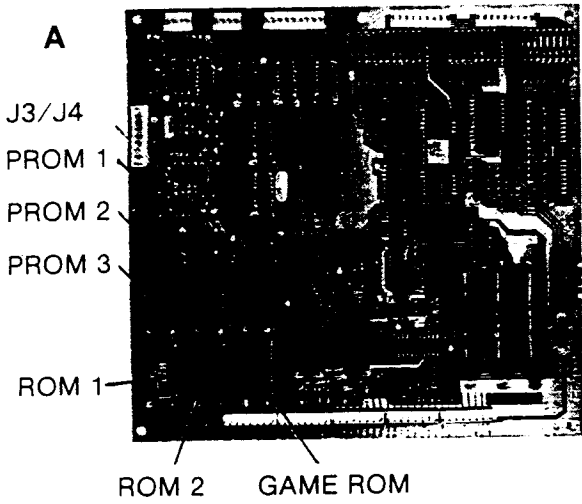

G D8000 Master Display Board.  
H D8169 Master Display Board.

I Slave Display Board.

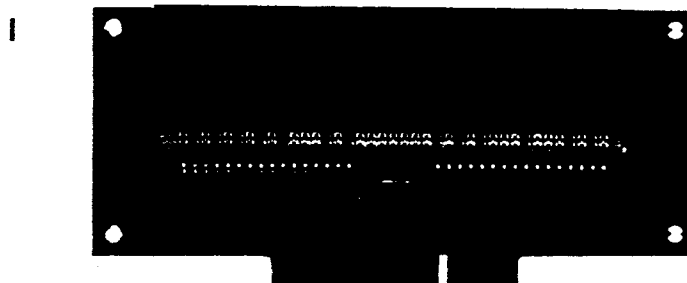
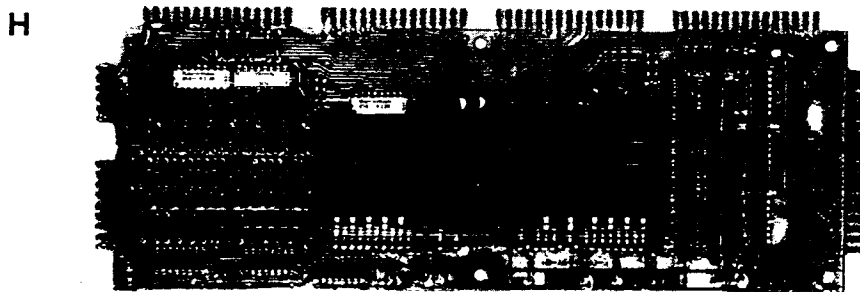
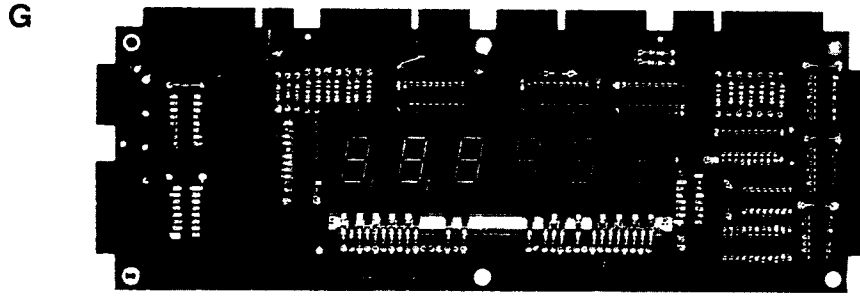

J D8224 Sound Board  
K D8224 Sound Board with optional C8228  
Speech Module

L D8224 Sound Board with optional C8226  
Speech Module

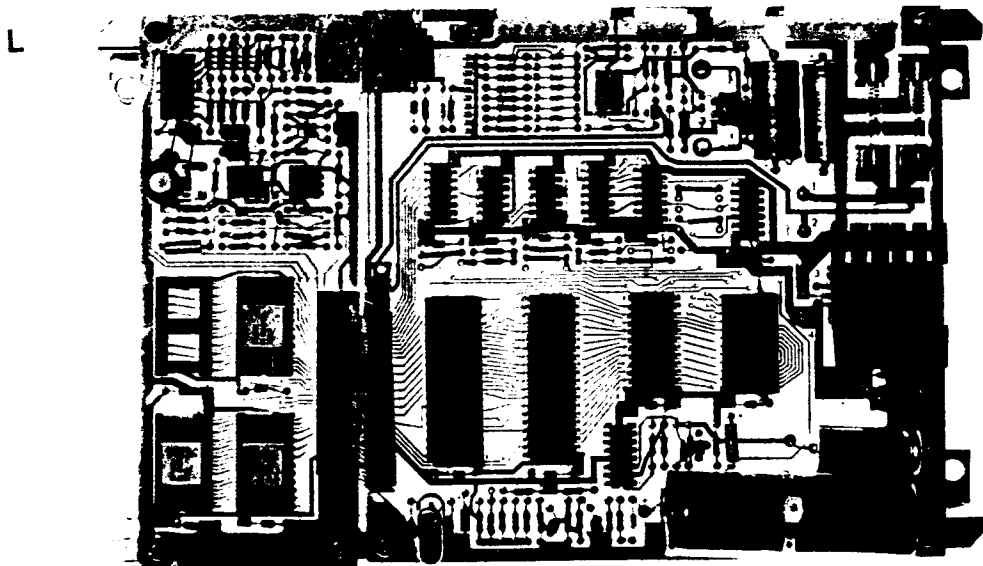
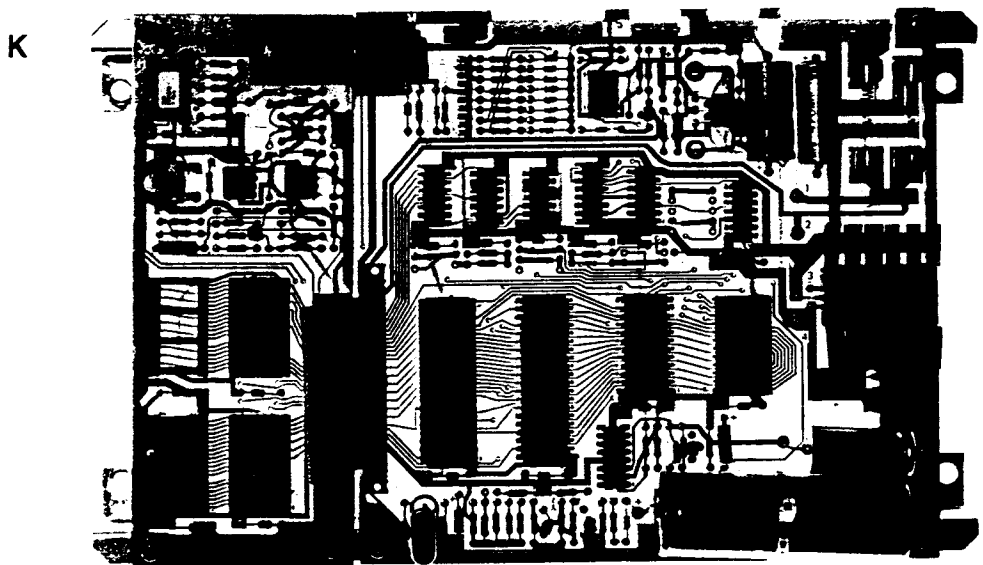
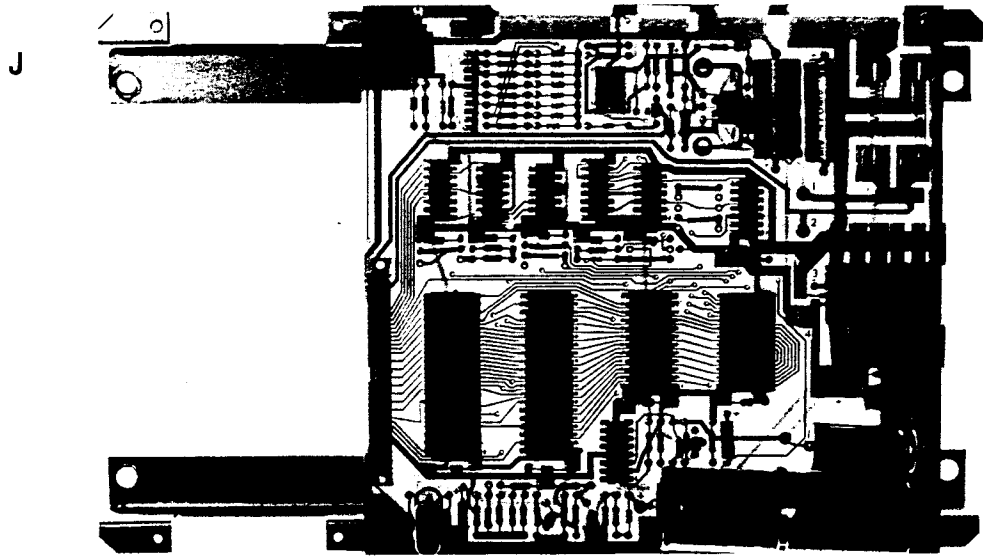

**Location of Major Assemblies**

- A Master Display
- B Player 1 Display
- C Player 2 Display
- D Player 3 Display
- E Player 4 Display
- F Driver Board
- G CPU Board
- H Power Supply Board

- I Optional Speech Module
- J Sound Board
- K Keylock for Backglass
- L Fuse Card
- M Lamp Bridge Rectifier
- N Solenoid Bridge Rectifier
- O Transformer
- P 6C1 Lamp Capacitor

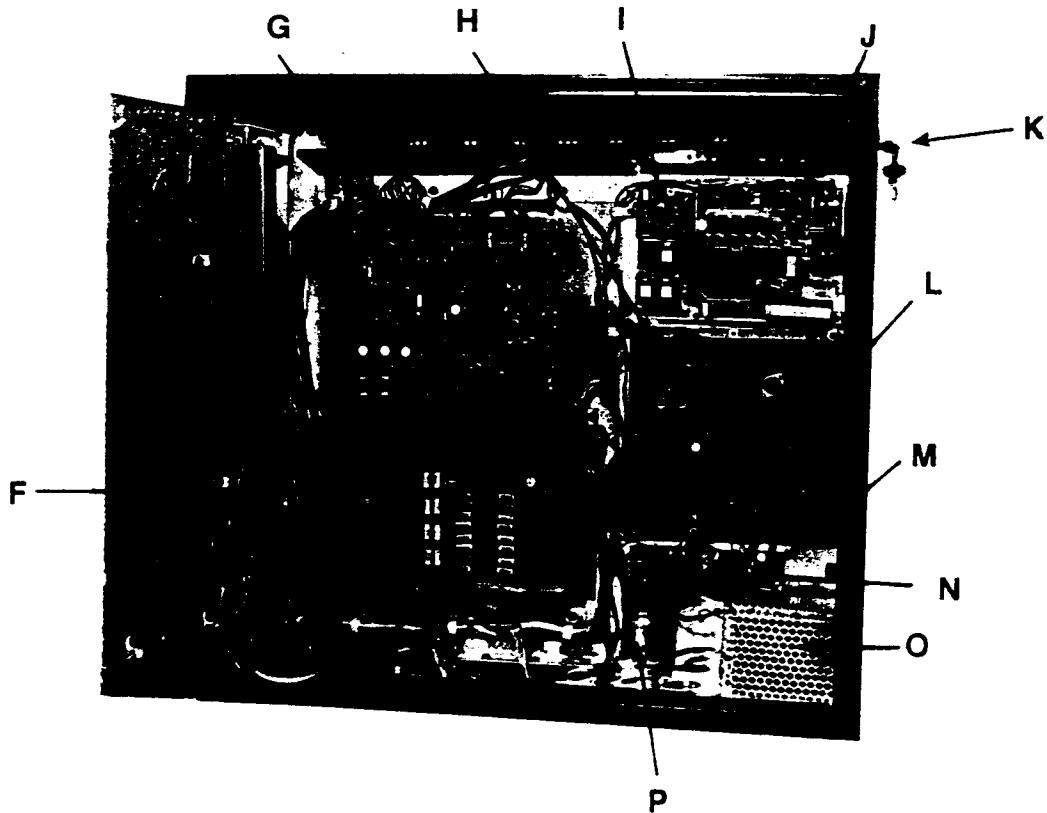
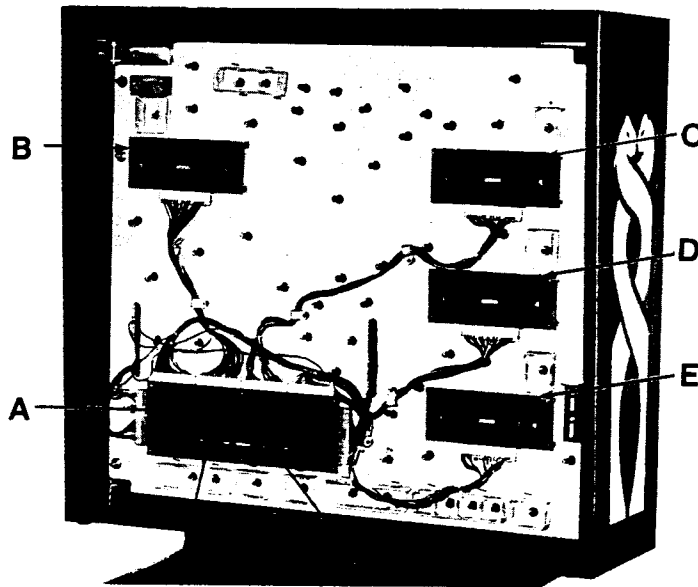

- Q Coin Lockout Relay
- R Diagnostic Switches
- S Memory Protect Interlock
- T Ball Roll Tilt
- U Credit Knocker
- V Volume Control

- W Plumb Bob Tilt
- X Slam Tilt
- Y Speaker
- Z Line Fuse
- AA Line Filter and Varistor

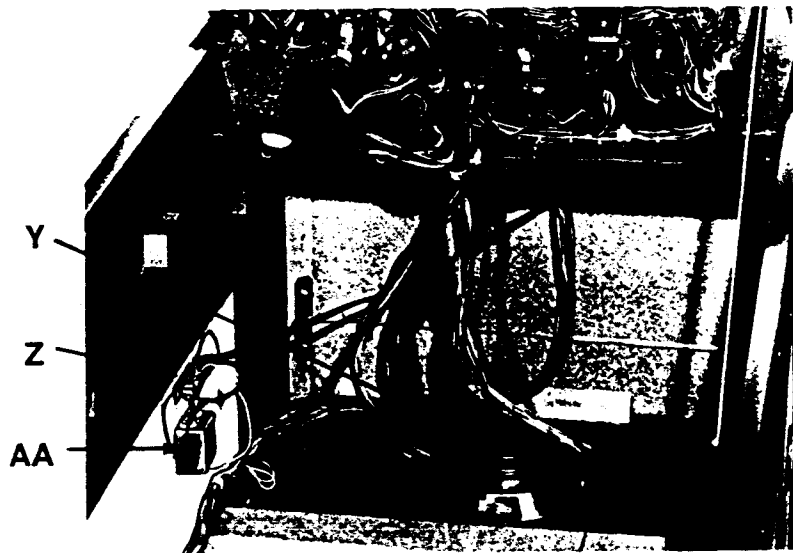
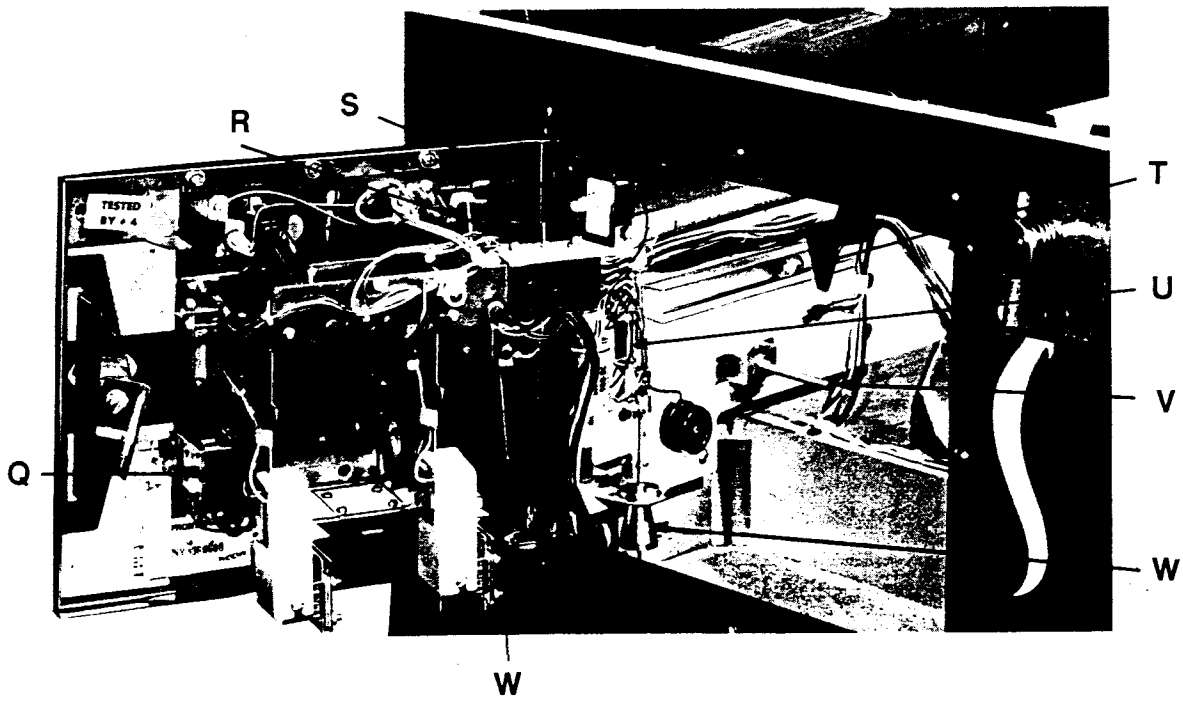

## SECTION 2 MECHANICAL MAINTENANCE

### General Switch Blade Adjustments

There are different types of switch blades used in any game. Various lengths, thickness and forms are selected characteristics to satisfy specific operational conditions (bounce, current capacity, etc.). For this reason, always use a blade of the same type for replacement. Basic guidelines for switch adjustments follow:

1. Never kink or bend a blade sharply; adjust with a sweeping, bowing motion with a switch adjusting tool or duckbill pliers.
2. Before adjusting any switch, check that the screw holding the switch stack is tight. This is recommended because spacers in the switch stack occasionally shrink causing a poor adjustment.
3. Except when otherwise indicated, blade type switches should have at least 1/32 inch between open contacts and have at least a 1/32 inch follow-thru when closed.
4. First adjust the actuating blade for approximate gapping and the other blade for the final gap and for follow-thru.

### Contact Care

1. Switch contacts should be cleaned only when they cause a malfunction.
2. For flipper button and flipper end-of-stroke switches, remove tarnish with a contact file and then burnish. Severely burnt contacts should be replaced as an assembly.
3. All other types of contacts MUST NOT be filed or burnished.
4. To clean contacts of other blade type switches, close the contacts on a clean piece of paper about the thickness of a business card and wipe gently until the contacts are clean.
5. For drop target switches, remove the two screws securing the circuit board. Clean the circuit board plating with a rag and pencil eraser. Carefully clean the wiper contacts with a burnishing tool - do not use an abrasive.

### Rollover Switches

Rollover Switches are activated by a wire form or button which is actuated by the ball.

1. Before adjustment, make sure that the wire form rollover is centered in the slot or that the switch blades are positioned under the button actuator.
2. Adjust the long blade (closest to the playfield) to hold the rollover up. Check this condition with the playfield lowered.

3. With the playfield up, adjust the short blade for 1/16 inch contact gap.
4. The backup blade (which prevents vibration) should be adjusted parallel to and just barely in contact with the shorter blade.

### Tilt Switches

1. To make the plumb bob tilt more sensitive, raise the plumb bob on the shaft. To make it less sensitive, lower the bob on the shaft.
2. To make the ball roll tilt more sensitive, raise the assembly at the front pivot slot. To make it less sensitive, lower the assembly at the front pivot slot.
3. The slam tilt and playfield tilt switches are adjusted by forming the switch blades.

### Flippers

Flippers are controlled by the flipper pushbuttons at each side of the cabinet. Each coil consists of two windings: a pull-in winding and a lighter gauge hold-in winding. The hold-in winding is normally bypassed by a closed switch.

The pull-in winding produces a strong stroke. However, if this winding were to remain energized by the player it would overheat. To reduce this high current, the hold-in winding is put in series with the pull-in winding by opening the end-of-stroke switch.

1. Adjust the long blade so that it is moved by the flipper pawl assembly for about the last 1/8 inch of movement.
2. Manually depress the plunger fully and adjust for approximately 3/32 inch gap.
3. There should be about 1/32 inch follow-thru with the plunger released.
4. NEVER LUBRICATE the plunger; use coin machine lubricant where required on the link assembly.
5. For weak or sluggish flipper action, check for all the following:
  - a. Dirty, pitted, or misadjusted flipper button or end of stroke contacts.
  - b. Worn out coil sleeves.
  - c. Loose or broken bushing.
  - d. Worn out fiber links.
  - e. Weak or broken return spring.
  - f. Coil loose
  - g. Loose screws
  - h. Flipper binding on playfield.



### SECTION 3 GAME ADJUSTMENTS

This section provides information for making game adjustments and reviewing game status. Williams now provides a greatly simplified method of customizing the game to the location or the operator's requirements. This section provides detailed procedures for making these changes.

There are four switches, all accessible from the coin door (Figure 1) or the front of the cabinet, which are used to display and change game features:

1. AUTO-UP/MANUAL-DOWN toggle switch (inside coin door)
2. ADVANCE pushbutton (inside coin door)
3. High Score Reset switch (inside coin door)
4. Credit Button—front of cabinet

#### General Procedure

Game status functions are displayed and can be set in test 04. To enter test 04, the AUTO-UP/MANUAL-DOWN switch is set to AUTO-UP and the ADVANCE pushbutton is depressed in the game over mode. Test 04 will be entered with the number of credits display showing 04 and the ball in play display showing 00.

If problems are encountered making game adjustments (for example, the ADVANCE pushbutton does not function after entering test 04) refer to troubleshooting in Section 6.

Refer to Table 1. Functions 00 through 12 are system audit totals and cannot be changed from the coin door. Functions 13 through 35 can all be adjusted from the coin door.

In test 04, to advance from the system audit totals to game feature status display, the AUTO-UP/MANUAL-DOWN switch is first set to AUTO-UP. Each time the ADVANCE pushbutton is depressed, the display will advance to the next higher function number. Holding the ADVANCE pushbutton depressed causes the function numbers to advance rapidly. With the AUTO-UP/MANUAL-DOWN switch set to MANUAL-DOWN, depressing (or holding down) the ADVANCE pushbutton causes the function numbers to decrease (from 00 to 35 to 34, etc.).

With the desired function number showing in the ball in play display, the current setting is shown on the Player 1 display. With the AUTO-UP/MANUAL-DOWN switch in the AUTO-UP position, depressing the Credit Button advances the value of the current setting on the Player 1 display. Holding the credit button depressed causes the value to advance rapidly. With the AUTO-UP/MANUAL-DOWN switch set to MANUAL-DOWN, depressing (or holding in) the credit button causes the value to decrease. **The value left showing on the display is the new current setting.**

After all changes have been made and reviewed using test 04, the game is turned OFF and then back ON to return to the game over mode.

#### High Score to Date

Depressing the High Score Reset switch in the game over mode changes the current high score to date (Function 12) to the value of the backup high score to date (Function 13).

The value of function 13 can be changed to any multiple of 10,000 points. With the value of function 13 set to zero, the high score to date feature is disabled. To change the backup high score to date, proceed as follows:

1. If not already in test 04, enter test 04 in one of the following ways:
  - a. From the game over mode, set the AUTO-UP/MANUAL-DOWN switch to AUTO-UP and depress the ADVANCE pushbutton.
  - b. From diagnostics, set the AUTO-UP/MANUAL-DOWN switch to AUTO-UP and depress the ADVANCE pushbutton to advance the diagnostics to test 04.
2. Set the AUTO-UP/MANUAL-DOWN switch to the desired position and operate the advance pushbutton until function 13 is indicated on the ball in play display. The backup high score to date is indicated in the Player 1 display.

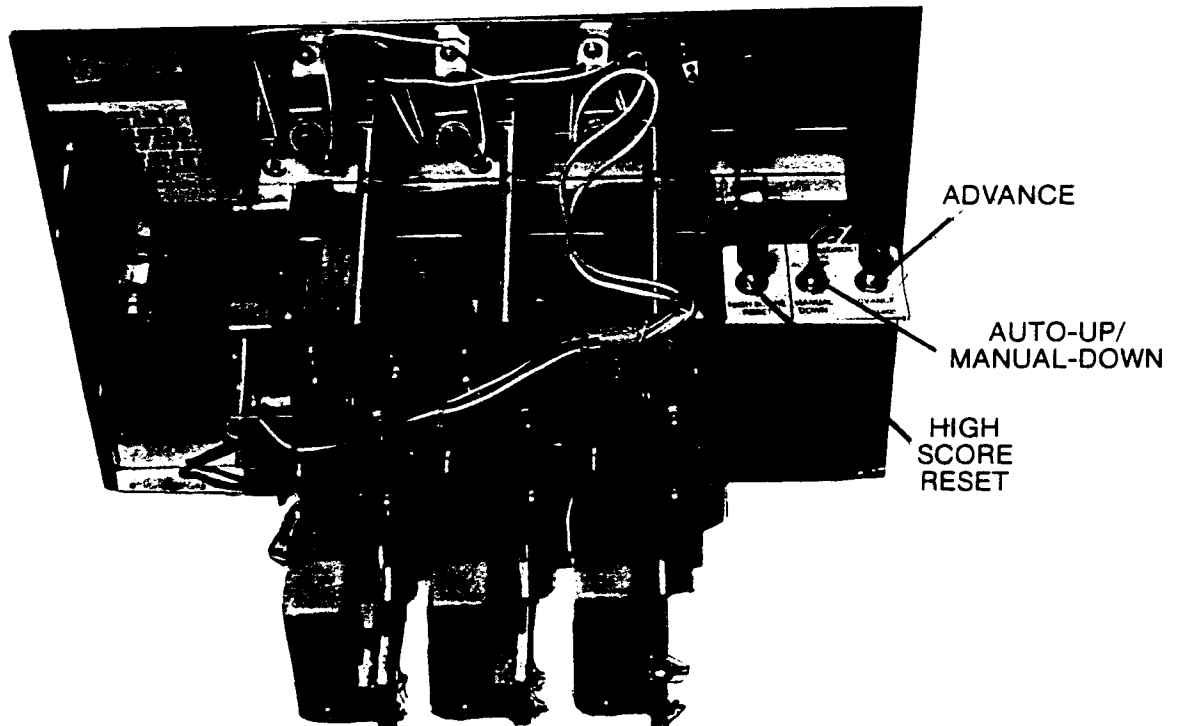

Figure 1. Coin Door Diagnostic Switches

Table 1. Game Adjustments

FUNCTION	DESCRIPTION	NOTES	FACTORY SETTING	Notes:
00	Game Identification	1	1ggg n	1. Game Identification in Function 00 readout indicates game number (ggg) and revision level (n) of PROMs or Game ROM.
01	Coins, Left Chute (Closest to coin door hinge)	2	---	2. Functions 01-11 cannot be changed from the coin door; however they can be set to zero as described in Section 4.
02	Coins, Center Chute	2	---	
03	Coins, Right Chute	2	---	
04	Total Paid Credits	2	---	3. Total Credits (Function 08) is the sum of Function 04 and as applicable, Functions 05, 06, and 07.
05	Total Specials	2	---	
06	Total Replay (Extra Ball) Scores	2	---	
07	Match and High Score to Date Credits	2	---	
08	Total Credits	2,3	---	4. Total Extra Balls (Function 09) is the sum of the game extra ball feature and Functions 05 and 06, as applicable.
09	Total Extra Balls	2,4	---	
10	Total Ball Time in Minutes	2	---	
11	Total Number of Balls Played	2	---	
12	Current High Score to Date	5	*	5. Current High Score to Date (Function 12) can be changed to the value of the Backup High Score to Date (Function 13) by operating the HIGH SCORE RESET switch while in the game over mode.
13	Backup High Score to Date	6	*	
14	Replay 1 Score	7	*	
15	Replay 2 Score	7	*	6. Function 13 may be set to any multiple of 10,000 points. Setting Function 25 to zero with Function 13 set to any score but zero permits the High Score to Date feature to operate but no credits are awarded.
16	Replay 3 Score	7	*	
17	Replay 4 Score	7	0	
18	Maximum Credits	8	20	
19	Standard and Custom Pricing Control (00-07)	9	*	7. Functions 14-17 (Replay Scores) may be set to any multiple of 10,000 points. Setting a function to zero disables the replay score point. <b>Always disable the Replay 4 level first, with ascending values.</b>
20	Left Coin Slot Multiplier	9	*	
21	Center Coin Slot Multiplier	9	*	
22	Right Coin Slot Multiplier	9	*	
23	Coin Units Required for Credit	9	*	
24	Coin Units Bonus Point	9	*	8. Setting Maximum Credits (Function 18) to zero places the game in a <b>free play mode</b> .
25	High Score Credits	6	03	
26	Match (00 ON, 01 OFF)	---	00	9. A typical factory setting for pricing is shown. With Function 19 set to 00, Functions 20-24 must be set manually. Refer to Table 2 or 3 for seven standard pricing schemes (selected by values of 01-07 for Function 19) and custom pricing values.
27	Special	---	00	
28	00 = Awards Credit 01 = Awards Extra Ball 02 = Awards Points Scoring Awards 00 = Credits at Replay Score 01 = Extra Ball at Replay Score Maximum Plumb Bob Tilts (1-9) Number of Balls (03 or 05)	---	00 03 03	
29	Unique Game Adjustments	---	*	
30		---		
31		---		
thru		---		
35		---		

\* Indicates settings are game-dependent.

3. To change the backup high score to date, proceed as follows:
  - a. To lower the backup value set the AUTO-UP/MANUAL-DOWN switch to MANUAL-DOWN.  
To raise the backup value, set it to AUTO-UP.
  - b. Operate the credit button until the desired backup value is indicated on the player 1 display.

#### NOTE

To disable the high score to date feature, set function 13 to zero.

4. If no further game adjustments are required, turn the game OFF and back ON to return to the game over mode.

#### Replay Scores

There are four possible replays awarded from scoring. The factory setting for the first three replay scores are provided in Table 1 and on the instruction booklet inside the game. The fourth replay is disabled. Replay 1 is function 14, replay 2 function 15, replay 3 function 16, and replay 4 function 17. Replay points can be increased or decreased by any multiple of 10,000 points. To make changes to replay points, proceed as follows:

1. If not already in test 04, enter test 04 in one of the following ways:
  - a. From the game over mode, set the AUTO-UP/MANUAL-DOWN switch to AUTO-UP and depress the ADVANCE pushbutton.
  - b. From diagnostics, set the AUTO-UP/MANUAL-DOWN switch to AUTO-UP and depress the ADVANCE pushbutton to advance the diagnostics to test 04.
2. Set the AUTO-UP/MANUAL-DOWN switch to the desired position and operate the ADVANCE pushbutton until function 14 is indicated on the ball in play display.
3. To change the score for Replay 1, proceed as follows:
  - a. To raise the replay points, set the AUTO-UP/MANUAL-DOWN switch to AUTO-UP.  
To lower the replay points, set it to MANUAL-DOWN.
  - b. Operate the Credit button until the desired value is indicated on the Player 1 display.

#### NOTE

To disable any replay point, raise or lower the value in the Player 1 display to zero.

4. With the AUTO-UP/MANUAL-DOWN switch set to AUTO-UP, depress the ADVANCE pushbutton one time. Function 15 is indicated on the ball in play display and the current value of replay 2 is indicated on the Player 1 display.
5. To change the score for replay 2, perform steps 3a and 3b.
6. Repeat step 4 to display Function 16 on the ball in play display and the replay 3 score in the Player 1 display.

7. To change the score for replay 3, perform steps 3a and 3b.
8. Repeat step 4 to display Function 17 on the ball in play display and the replay 4 score on the Player 1 display.
9. To change the replay 4 score, perform steps 3a and 3b.
10. If no further game adjustments are required, turn the game OFF and back ON to return to the game over mode.

#### Maximum Credits

Maximum credits is the number of credits that can be posted (by putting coins in the game or free credit awards) before the coin lockout relay is released. Maximum credits is Function 18 and the factory setting is 20. Maximum credits may be set to any value from 1 to 99; setting maximum credits to zero sets the game to a free play mode.

To make changes to maximum credits, proceed as follows:

1. If not already in test 04, enter test 04 in one of the following ways:
  - a. From the game over mode, set the AUTO-UP/MANUAL-DOWN switch to AUTO-UP and depress the ADVANCE pushbutton.
  - b. From diagnostics, set the AUTO-UP/MANUAL-DOWN switch to AUTO-UP and depress the ADVANCE pushbutton to advance the diagnostics to test 04.
2. Set the AUTO-UP/MANUAL-DOWN switch to the desired position and operate the ADVANCE pushbutton until Function 18 is indicated on the ball in play display.
3. To raise the maximum credits set the AUTO-UP/MANUAL-DOWN switch to AUTO-UP.  
To lower the maximum credits set it to MANUAL-DOWN.
4. Operate the Credit button until the desired number of maximum credits is indicated on the Player 1 display.
5. If no further game adjustments are required, turn the game OFF and back ON to return to the game over mode.

#### Game Pricing

##### Standard Game Pricing

This feature accounts for differences in coin door mechanisms and how credits are awarded. Function 19 can be set to select one of seven standard game pricing schemes with fixed values for Functions 20 through 24. (Function 19 can also be set to allow custom pricing schemes where Functions 20 through 24 are set with appropriate values as described in the CUSTOM GAME PRICING paragraphs).

To select one of the standard pricing schemes, proceed as follows:

1. If not already in test 04, enter test 04 in one of the following ways:
  - a. From the game over mode, set the AUTO-UP/MANUAL-DOWN switch to AUTO-UP and depress the ADVANCE pushbutton.

Table 2. Standard and Custom Price Settings

COIN DOOR MECHANISM	CREDITS	FUNCTION					
		19	20	21	22	23	24
Twin-Quarter Quarter, Dollar, Quarter	1/25c, 3/50c, 7/\$1	00	03	12	03	02	12
	1/25c, 3/50c, 7/\$1 coin only	00	03	14	03	02	00
	1/25c, 7/\$1 coin only	00	01	07	01	01	00
	•1/25c, 3/50c, 6/\$1	01	01	04	01	01	02
	1/25c, 6/\$1 coin only	00	01	06	01	01	00
	•1/25c, 5/\$1	05	01	04	01	01	04
	1/25c, 5/\$1 coin only	00	01	05	01	01	00
	•1/25c, 4/\$1	02	01	04	01	01	00
1DM, 5DM, 2DM	1/50c, 3/\$1	00	01	04	01	02	04
	1/50c	00	01	04	01	02	00
	•2/1DM, 5/2DM, 14/5DM	03	13	65	26	05	65
	1/1DM, 3/2DM, 10/5DM	00	09	45	18	05	45
20-Cent, 50-Cent	1/20c, 3/50c	00	06	00	15	05	00
1 Franc, 5 Frank	•1/1F, 6/5F	04	01	00	05	01	05
	1/1F, 7/5F	00	06	00	30	05	30
25 Cent, 1 Guilder,	•1/25c, 4/1G	06	01	00	04	01	00
	1/25c, 5/1G	00	01	00	04	01	04
50 Yen, 100 Yen	•1/50Y, 2/100Y	07	01	00	02	01	00
1 Franc or Twin-1 Franc	1/1F, 3/2F	00	01	01	01	01	02
	1/1F	00	01	01	01	01	00
5 Franc, 10 Franc	•1/5F, 2/10F	07	01	00	02	01	00
	1/10F	00	01	00	02	02	00
Twin-2 Franc	•1/2F	02	01	04	01	01	00
10, 20 Franc Twin-1 Sucre	•1/10F, 2/20F	07	01	00	02	01	00
	1/3S, 2/5S	00	02	00	02	05	00

•Indicates standard price settings by adjusting only Function 19. For other price settings, set Function 19 to 00 and set Functions 20 through 24 to the values indicated in the chart.

- b. From diagnostics, set the AUTO-UP/MANUAL-DOWN switch to AUTO-UP and depress the ADVANCE pushbutton to advance the diagnostics to test 04.
  2. Set the AUTO-UP/MANUAL-DOWN switch to the desired position and operate the ADVANCE pushbutton until Function 19 is indicated on the ball in play display.
  3. Refer to Table 2 and determine the value of Function 19 required for the desired pricing scheme. (Standard pricing is set in **bold type**).
  4. **To raise** the value of Function 19 set the AUTO-UP/MANUAL-DOWN switch to AUTO-UP. **To lower**, set it to MANUAL-DOWN.
  5. Operate the Credit button until the value determined in step 3 is shown in the Player 1 display.
  6. **If no further game adjustments are required**, turn the game OFF and back ON to return to the game over mode.
1. If not already in test 04, enter test 04 in one of the following ways:
    - a. From the game over mode, set the AUTO-UP/MANUAL-DOWN switch to AUTO-UP and depress the ADVANCE pushbutton.
    - b. From diagnostics, set the AUTO-UP/MANUAL-DOWN switch to AUTO-UP and depress the ADVANCE pushbutton to advance the diagnostics to test 04.
  2. Set the AUTO-UP/MANUAL-DOWN switch to the desired position and operate the ADVANCE pushbutton until Function 19 is indicated on the number of credits display.
  3. Set the AUTO-UP/MANUAL-DOWN switch to MANUAL-DOWN and operate the Credit button until 00 is indicated for Function 19 on the Player 1 display. With Function 19 set to 00, Functions 20 through 24 are set to zero and now can be changed as required.
  4. Refer to Table 2 (or use the explanation following this procedure) and determine the required values for Functions 20 through 24.
  5. Set the AUTO-UP/MANUAL-DOWN switch to AUTO-UP and momentarily depress the ADVANCE pushbutton. Function 20 should be indicated on the ball in play display.
  6. For single chute coin doors, omit this step and leave the value of 00. For twin or 3-chute coin doors, operate the Credit button until the value for Function 20 determined in step 4 is indicated in the Player 1 display.

#### Custom Game Pricing -

With Function 19 set to zero, the five Functions 20 through 24 may be set manually for custom game pricing requirements. Functions 20, 21, and 22 relate to the type of coin door mechanism and Functions 23 and 24 relate to how credits are awarded. A large number of custom game pricing schemes are provided in Table 2 and are set in light type. If the required pricing scheme is not provided in Table 2, refer to the explanation that follows the procedure to determine the values for Functions 20 through 24. Proceed as follows:

7. Momentarily depress the ADVANCE pushbutton. Function 21 should be indicated on the ball in play display.
8. For twin chute coin doors, omit this step and leave the value of 00. For single and 3 chute coin doors, operate the Credit button until the value for Function 21 determined in step 4 is indicated on the Player 1 display.
9. Momentarily depress the ADVANCE pushbutton. Function 22 should be indicated on the ball in play display.
10. For single chute coin doors omit this step and leave the value of 00. For twin or 3-chute coin doors, operate the Credit button until the value for Function 22 determined in step 4 is indicated on the Player 1 display.
11. Momentarily depress the ADVANCE pushbutton. Function 23 should be indicated on the ball in play display.
12. Operate the credit button until the value for Function 23 determined in step 4 is indicated in the Player 1 display.
13. Momentarily depress the ADVANCE pushbutton. Function 24 should be indicated on the ball in play display.
14. Omit this step if no bonus credits are to be awarded for inserting a certain value of coins. To award bonus credits, operate the Credit button until the value for Function 24 determined in step 4 is indicated on the Player 1 display.
15. **If no other game adjustments are to be made**, turn the game OFF and back ON to return to the game over mode.

#### Pricing Formulas

There are five different functions used to set custom game pricing. Three pertain to the coin door mechanism and the other two determine how credits are awarded. Since there are many combinations of coin values and coin mechanisms, this explanation details how the functions relate to each other and provides a generalized procedure for defining the desired pricing scheme.

Proportional values are assigned to Functions 20, 21, and 22 for the left (closest to hinge on coin door), center, and right coin chute, respectively.

Function 23 defines the value of coins required for a single credit in relation to the proportional values assigned to functions 20, 21, and 22. Function 24 permits awarding a bonus credit for depositing some value of coin(s). A general procedure follows:

1. Determine the ratio of the coin chute values by dividing by the largest number that leaves a remainder of zero.

#### Examples:

25¢ 25¢ 25¢; ÷ 25 = 1:1:1  
 1DM 5DM 2DM; ÷ 1 = 1:5:2  
 25¢ - 1G; ÷ 4 = 1:0:4  
 5¢ 10¢ 25¢; ÷ 5 = 1:2:5

2. Determining the values of Functions 20 through 24 is done in one of two ways. The first method requires that bonus credit Function 24 be set to zero. The second method defines the Function 24 value. Since some pricing schemes may be implemented with either method, some with only the first method, and others with only the second method, both methods will have to be tried in some cases.

Both methods use the ratio calculated in step 1, the largest number of credits defined in the pricing scheme, and the number of smallest value coins required to obtain the largest number of credits.

#### Method 1

Function 20 = Cd × L  
 Function 21 = Cd × C  
 Function 22 = Cd × R  
 Function 23 = Cn × Lr  
 Function 24 = 00

#### Method 2

Function 20 = (Cd-1) × L  
 Function 21 = (Cd-1) × C  
 Function 22 = (Cd-1) × R  
 Function 23 = Cn × Lr  
 Function 24 = Cn × (Cd-1)

Where:

Cd = the largest number of credits in scheme  
 Cn = the number of smallest value coins required for Cd  
 L = Left chute ratio number  
 C = Center chute ratio number  
 R = Right chute ratio number  
 Lr = Lowest coin chute ratio

#### Examples:

**25¢ - 25¢ Coin door**  
**1 Play/25¢, 3 Plays/50¢**

Ratio = 1:0:1  
 L = 1  
 C = 0  
 R = 1  
 Lr = 1

In this example either method will produce proper values for functions 20-24.

#### Method 1

Cd = 3  
 Cn = 2 (two 25¢ coins for 3 plays)

Function 20 = Cd × L = 3 × 1 = 03  
 Function 21 = Cd × C = 3 × 0 = 00  
 Function 22 = Cd × R = 3 × 1 = 03  
 Function 23 = Cn × Lr = 2 × 1 = 02  
 Function 24 = 00

#### Method 2

Cd = 3  
 Cn = 2

Function 20 = (Cd-1) × L = (3-1) × 1 = 02  
 Function 21 = (Cd-1) × C = 00  
 Function 22 = (Cd-1) × R = 02  
 Function 23 = Cn × Lr = 2 × 1 = 02  
 Function 24 = Cn × (Cd-1) = 2 × (3-1) = 2 × 2 = 04

**5¢ 10¢ 25¢ Coin door**  
**1 Play/15¢, 2 Plays/25¢**

Ratio = 1:2:5  
 L = 1  
 C = 2  
 R = 5  
 Lr = 1

In this example, method 1 provides proper values but method 2 will not:

#### Method 1

Cd = -2  
 Cn = 5 (five 5¢ coins required for 2 plays)

Function 20 =  $Cd \times L = 2 \times 1 = 02$   
 Function 21 =  $Cd \times C = 2 \times 2 = 04$   
 Function 22 =  $Cd \times R = 2 \times 5 = 10$   
 Function 23 =  $Cn \times Lr = 5 \times 1 = 05$   
 Function 24 = 00

#### Method 2

$Cd = 2$   
 $Cn = 5$

Function 20 =  $(Cd-1) \times L = (2-1) \times 1 = 01$   
 Function 21 =  $(Cd-1) \times C = (2-1) \times 2 = 02$   
 Function 22 =  $(Cd-1) \times R = (2-1) \times 5 = 05$   
 Function 23 =  $Cn \times Lr = 5 \times 1 = 05$   
 Function 24 =  $Cn \times (Cd-1) = 5 \times (2-1) = 05$

By studying the values obtained in method 2 it will be determined that the values set up pricing for 2 plays for 25¢ (no plays for 15¢). This example shows that some pricing schemes can be set up using only one of the methods.

#### 20¢ - 50¢ Coin door 1 Play/20¢, 3 Plays/50¢

Ratio = 2:0:5

$L = 2$   
 $C = 0$   
 $R = 5$   
 $Lr = 2$

In this example, only method 1 will produce proper values.

#### Method 1

$Cd = 3$   
 $Cn = 2.5$  (two and one-half 20¢ coin required for 3 plays)

Function 20 =  $Cd \times L = 3 \times 2 = 06$   
 Function 21 =  $Cd \times C = 3 \times 0 = 00$   
 Function 22 =  $Cd \times R = 3 \times 5 = 15$   
 Function 23 =  $Cn \times Lr = 2.5 \times 2 = 05$   
 Function 24 = 00

#### High Score Credits

Function 25 determines the number of credits to be awarded when the current highest score is exceeded by a player. Note that the backup high score to date (Function 13) must be set to some value other than zero for the high score feature to operate. With Function 25 set to zero and Function 13 set to any value other than zero, the high score to date feature will still function but no credits will be awarded. To change the number of credits for exceeding the high score, proceed as follows:

1. If not already in test 04, enter test 04 in one of the following ways:
  - a. From the game over mode, set the AUTO-UP/MANUAL-DOWN switch to AUTO-UP and depress the ADVANCE pushbutton.
  - b. From diagnostics, set the AUTO-UP/MANUAL-DOWN switch to AUTO-UP and depress the ADVANCE pushbutton to advance the diagnostics to test 04.
2. Set the AUTO-UP/MANUAL-DOWN switch to the desired position and operate the ADVANCE pushbutton until Function 25 is indicated on the ball in play display.
3. **To increase** the number of credits, set the AUTO-UP/MANUAL-DOWN switch to AUTO-UP.  
**To decrease** the number of credits, set it to MANUAL-DOWN.

4. Operate the credit button until the desired number of high score credits is indicated on the player 1 display.
5. **If no further game adjustments are required**, turn the game OFF and back ON to return to the game over mode.

#### Match

Function 26 controls the match features. If this function is set to 00, the match feature is on. If it is set to 01, the feature is off. With the match feature on, a free credit is awarded at game over when the last two digits of a players score match the digits shown in the ball in play display.

To change the match feature, proceed as follows:

1. If not already in test 04, enter test 04 in one of the following ways:
  - a. From the game over mode, set the AUTO-UP/MANUAL-DOWN switch to AUTO-UP and depress the ADVANCE pushbutton.
  - b. From diagnostics, set the AUTO-UP/MANUAL-DOWN switch to AUTO-UP and depress the ADVANCE pushbutton to advance the diagnostics to test 04.
2. Set the AUTO-UP/MANUAL-DOWN switch to the desired position and operate the ADVANCE pushbutton until Function 26 is indicated on the ball in play display.
3. **To raise** the value of Function 26, set the AUTO-UP/MANUAL-DOWN switch to AUTO-UP.  
**To lower** the value, set it to MANUAL-DOWN.
4. Operate the credit button until the desired value is indicated on the player 1 display (00 for match on or 01 for match off).
5. **If no further adjustments are required**, turn the game OFF and back ON to return to the game over mode.

#### Special

Function 27 controls the special feature. If this function is set to 00, a special awards a free credit; with the feature set to 01 or 02, a special awards an extra ball or bonus points, respectively. To change the award for a special, proceed as follows:

1. If not already in test 04, enter test 04 in one of the following ways:
  - a. From the game over mode, set the AUTO-UP/MANUAL-DOWN switch to AUTO-UP and depress the ADVANCE pushbutton.
  - b. From diagnostics, set the AUTO-UP/MANUAL-DOWN switch to AUTO-UP and depress the ADVANCE pushbutton to advance the diagnostics to test 04.
2. Set the AUTO-UP/MANUAL-DOWN switch to the desired position and operate the ADVANCE pushbutton until Function 27 is indicated on the ball in play display.
3. **To raise** the value of Function 27, set the AUTO-UP/MANUAL-DOWN switch to AUTO-UP.  
**To lower** the value, set it to MANUAL-DOWN.

4. Operate the Credit button until the desired value is indicated in the player 1 display:
  - 00 - Special Awards Credit
  - 01 - Special Awards Extra Ball
  - 02 - Special Awards Points
5. **If no other game adjustments are required**, turn the game OFF and back ON to return to the game over mode.

#### Scoring Awards

Function 28 controls whether exceeding replay points awards a free credit or an extra ball. Setting the function to 00 awards a credit; setting it to 01 awards an extra ball. To adjust scoring, proceed as follows:

1. If not already in test 04, enter test 04 in one of the following ways:
  - a. From the game over mode, set the AUTO-UP/MANUAL-DOWN switch to AUTO-UP and depress the ADVANCE pushbutton.
  - b. From diagnostics, set the AUTO-UP/MANUAL-DOWN switch to AUTO-UP and depress the ADVANCE pushbutton to advance the diagnostics to test 04.
2. Set the AUTO-UP/MANUAL-DOWN switch to the desired position and operate the ADVANCE pushbutton until Function 28 is indicated on the ball in play display.
3. **To raise** the value of Function 28, set the AUTO-UP/MANUAL-DOWN switch to AUTO-UP. **To lower** the value, set it to MANUAL-DOWN.
4. Momentarily depress the Credit button so that the desired value is indicated on the player 1 display (00 for credit, 01 for extra ball).
5. **If no further adjustments are required**, turn the game OFF and back ON to return to the game over mode.

#### Maximum Plumb Bob Tilts

Function 29 controls the multiple tilt feature. The plumb bob tilt can be set so that the ball in play does not tilt the first time that the bob contacts the ring. All tilts do not have this capability.

To change the number of plumb bob tilts (1-9) proceed as follows:

1. If not already in test 04, enter test 04 in one of the following ways:
  - a. From the game over mode, set the AUTO-UP/MANUAL-DOWN switch to AUTO-UP and depress the ADVANCE pushbutton.
  - b. From diagnostics, set the AUTO-UP/MANUAL-DOWN switch to AUTO-UP and depress the ADVANCE pushbutton to advance the diagnostics to test 04.
2. Set the AUTO-UP/MANUAL-DOWN switch to the desired position and operate the ADVANCE pushbutton until Function 29 is indicated on the ball in play display.
3. **To increase** the number of plumb bob tilts, set the AUTO-UP/MANUAL-DOWN switch to AUTO-UP. **To decrease** the number, set it to MANUAL-DOWN.

4. Operate the credit button until the desired number of plumb bob tilts is indicated on the player 1 display.
5. **If no further game adjustments are required**, turn the game OFF and back ON to return to the game over mode.

#### Number of Balls

Function 30 controls the number of regular balls. To adjust Function 30 proceed as follows:

1. If not already in test 04, enter test 04 in one of the following ways:
  - a. From the game over mode, set the AUTO-UP/MANUAL-DOWN switch to AUTO-UP and depress the ADVANCE pushbutton.
  - b. From diagnostics, set the AUTO-UP/MANUAL-DOWN switch to AUTO-UP and depress the ADVANCE pushbutton to advance the diagnostics to test 04.
2. Set the AUTO-UP/MANUAL-DOWN switch to the desired position and operate the ADVANCE pushbutton until Function 30 is indicated on the ball in play display.
3. **To increase** the number of regular balls per game, set the AUTO-UP/MANUAL-DOWN switch to AUTO-UP. **To decrease** the number, set it to MANUAL-DOWN.
4. Operate the credit button until the desired number of balls is indicated in the player 1 display.
  - 03 - 3 Ball Play
  - 05 - 5 Ball Play
5. **If no further game adjustments are required**, turn the game OFF and back ON to return to the game over mode.

#### Unique Game Adjustments

Functions 31 through 35 provide game-dependent adjustments for the Extra Ball feature, liberal to conservative play, playfield restore, and (when applicable) sound options. For adjustment values, refer to the supplemental manual or to the game adjustment and diagnostic procedures booklet provided with the specific game. Proceed as follows:

1. If not already in test 04, enter test 04 in one of the following ways:
  - a. From the game over mode, set the AUTO-UP/MANUAL-DOWN switch to AUTO-UP and depress the ADVANCE pushbutton.
  - b. From diagnostics, set the AUTO-UP/MANUAL-DOWN switch to AUTO-UP and depress the ADVANCE pushbutton to advance the diagnostics to test 04.
2. Set the AUTO-UP/MANUAL-DOWN switch to the desired position and operate the ADVANCE pushbutton until the function number is indicated on the ball in play display.
3. **To raise** the value, set the AUTO-UP/MANUAL-DOWN switch to AUTO-UP. **To lower** the value set it to MANUAL-DOWN.
4. Operate the credit button until the desired value is indicated on the player 1 display.

- Repeat steps 2, 3, and 4 for any other unique game adjustments.
- If no further game adjustments are required, turn the game OFF and back ON to return to the game over mode.

**Restoring Factory Settings**

The factory settings are restored using the coin door switches and two switches on the CPU Board. Refer to Figures 1 and 2 and proceed as follows:

- With the game in the game over mode, set the AUTO-UP/MANUAL-DOWN switch to MANUAL-DOWN and momentarily depress the ADVANCE pushbutton. All displays should go blank. **The coin door must remain open.**
- Remove the backglass and unlatch and open the insert door.
- Set all switches on the MASTER COMMAND switch to OFF (move to the right).
- Set switch 7 on the MASTER COMMAND switch to ON (move to the left).
- Momentarily depress the MASTER COMMAND ENTER pushbutton. The LEDs should blink once.
- Turn the game OFF and back ON two times to return to the game over mode.

**SECTION 4  
GAME BOOKKEEPING AND EVALUATION**

This section provides an explanation of the built-in game bookkeeping features. The bookkeeping and game evaluation features consist of:

**TEST 04**

READOUT	DESCRIPTION
00	PROM Identification (Game No. and Revision level)
01	Coins Left Chute (Closest to coin door hinge)
02	Coins Center Chute
03	Coins Right Chute
04	Total Paid Credits
05	Total Number of Specials
06	Total Number of Credits or Extra Balls for Replay Scores
07	Match/High Score to Date Credits
08	Total Credits (Sum of 04-07 as applicable)
09	Total Extra Balls (Sum of Extra Ball features, and 05 and 06 as applicable)
10	Total Ball Time in Minutes
11	Total Number of Balls played
12	Current High Score to Date

**Feature Access**

All of these features can be accessed from the coin door (See Figure 1). To obtain bookkeeping totals proceed as follows:

- With the game in the **game over mode**, set the AUTO-UP/MANUAL-DOWN switch to AUTO-UP.
- Momentarily depress the ADVANCE pushbutton. The game will go immediately to diagnostics test 04. The number of credits display indicates 04; the ball in play display indicates function 00, and the Player 1 display indicates the PROM identification (game number and revision level).

**NOTE**

If indications are not as stated, refer to troubleshooting procedures in Section 6.

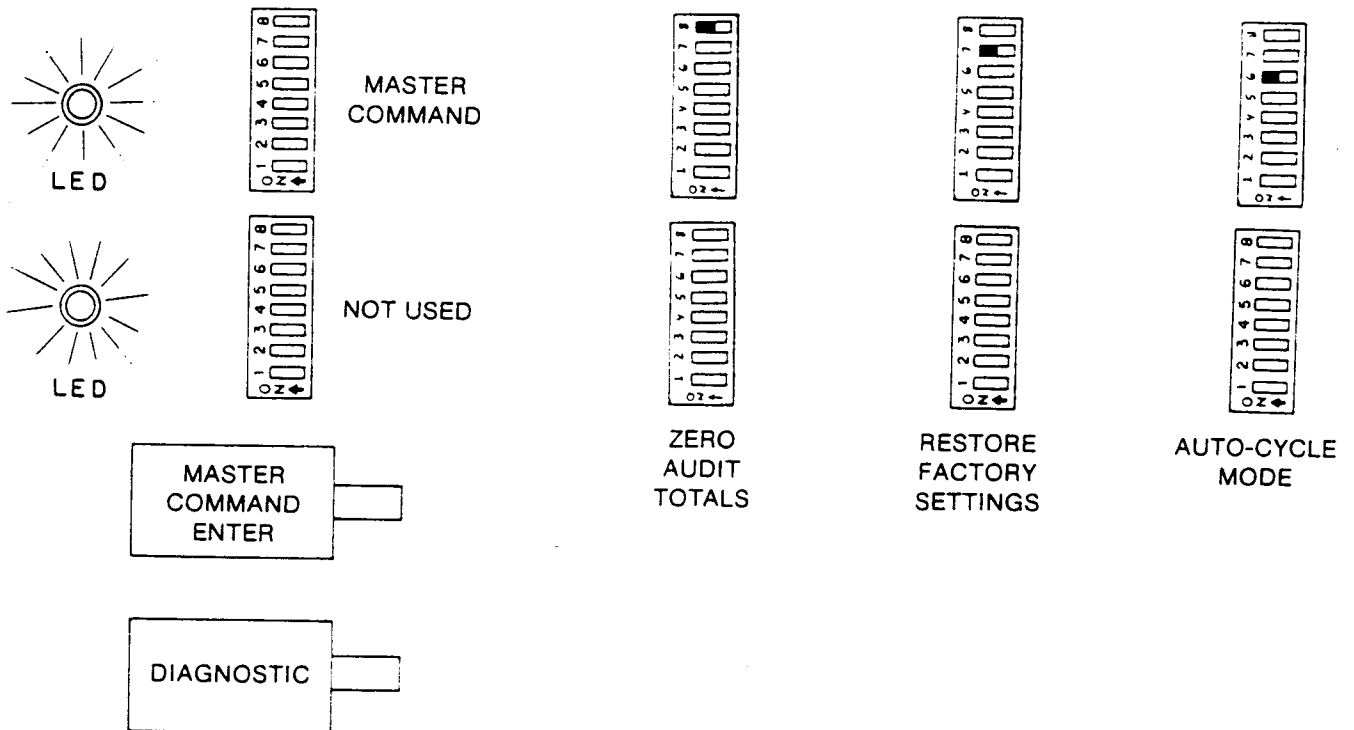

Figure 2. Master Command Switch Settings



3. Momentarily depress the ADVANCE pushbutton. Function 01 is indicated on the number of credits display and the number of coins through the left chute (closest to coin door hinge) is indicated on the Player 1 display.
4. Repeat step 3 to obtain the readings for functions 02 (coins through center chute), 03 (coins through right chute), and 04 (total paid credits).

#### NOTE

If it is desired to recheck a total that you have advanced past, set the AUTO-UP/MANUAL-DOWN switch to MANUAL-DOWN and operate the ADVANCE pushbutton. This will cause the function number to decrease (from 04 to 03, etc.)

5. Operate the ADVANCE pushbutton until Function 05 is indicated in the ball in play display. The total number of Special awards is indicated on the Player 1 display.
6. Operate the ADVANCE pushbutton until Function 06 is indicated in the ball in play display. The total number of credits or extra balls for replay scores is indicated in the Player 1 display.
7. Operate the ADVANCE pushbutton until Function 07 is indicated on the ball in play display. The total credits awarded for the Match and High Score to Date features is indicated on the player 1 display.
8. Operate the ADVANCE pushbutton until Function 08 is indicated on the ball in play display. The total credits (sum of paid credits and, as applicable, Functions 06 through 08).
9. The percentage of paid credits may be calculated as follows:  

$$\text{Function 04} \div \text{Function 08} = \% \text{ paid credits}$$
10. Operate the ADVANCE pushbutton until Function 09 is indicated on the ball in play display. The total number of extra balls (sum of the game extra ball feature, Special, SUPER FLASH, and Function 06, as applicable).
11. Operate the ADVANCE pushbutton until Function 10 is indicated on the ball in play display. The total ball time in minutes is indicated on the player 1 display.
12. Operate the ADVANCE pushbutton until Function 11 is indicated on the ball in play display. The total number of balls is indicated on the player 1 display.
13. Operate the ADVANCE pushbutton until Function 12 is indicated on the ball in play display. The current High Score to Date is indicated on the player 1 display.
14. Turn the game OFF and back ON to return to the game over mode. If desired, reset the High Score to Date to the backup value and reset the audit totals to zero as explained in the following paragraphs.

#### High Score Reset

The current High Score to Date (Function 12) may be reset to the backup High Score to Date (Function 13) from the coin door. To adjust the backup High Score to Date, see Section 3. **With the game in the game over mode**, momentarily depress the HIGH SCORE RESET pushbutton.

#### Resetting Audit Totals

Functions 01 to 11 may be reset to zero using switches located on the CPU Board. Refer to Figure 2, there are two

8-position miniature slide switches and two pushbutton switches located on the right side of the CPU Board. The lower 8-position switch is not used and the lower (DIAGNOSTIC) pushbutton switch is used only for troubleshooting. Switch number 8 on the MASTER COMMAND slide switch is set to ON (moved to the left) and all other switches are set to OFF (moved to the right). Then the MASTER COMMAND ENTER pushbutton is depressed. To reset Function 01 through 11 to zero, proceed as follows:

1. **With the game in the game over mode**, set the coin door AUTO-UP/MANUAL-DOWN switch to MANUAL-DOWN.
2. Momentarily depress the ADVANCE pushbutton. All displays should go blank.
3. Unlock and remove the backglass and open the insert door.
4. Move all switches on the MASTER COMMAND slide switch to the right (OFF).
5. Move switch 8 on the MASTER COMMAND slide switch to the left (ON).
6. Momentarily depress the MASTER COMMAND ENTER pushbutton.
7. Close and latch the insert door and replace the backglass. Turn the game OFF and back ON to return to the game over mode.

## SECTION 5 BUILT-IN DIAGNOSTICS

This section describes the built-in diagnostics used to test the displays, lamps, solenoids, and switches in the game. Control of diagnostics is from two switches in the coin door. An Auto-Cycle test, which is initiated by switches on the CPU Board, repeatedly tests the displays, lamps, and solenoids. Refer to Figure 3. In addition to the tests described in this section, there are CPU Board and Sound Board self-tests which are described in Section 6, Maintenance.

### Display Digits Test

This test allows a complete test of all the displays. Proceed as follows:

1. From the game over mode, set the AUTO-UP/MANUAL-DOWN switch on the coin door to MANUAL-DOWN.
2. Momentarily depress the ADVANCE pushbutton on the coin door. All displays should go blank.
3. Momentarily depress the ADVANCE pushbutton again. All displays should indicate all 0's.
4. Repeat step 3, as desired. The indication on the displays should sequence to all 1's, 2's, ... 9's, and 0's ...
5. If no further tests are required, turn the game OFF and back ON to return to the game over mode.

### Lamp Test—Test 01

This test causes all multiplexed lamps to blink on and off. Note that general illumination lamps are not controlled by this test or by any test. Proceed as follows:

1. Enter the Lamp Test in one of the following ways:

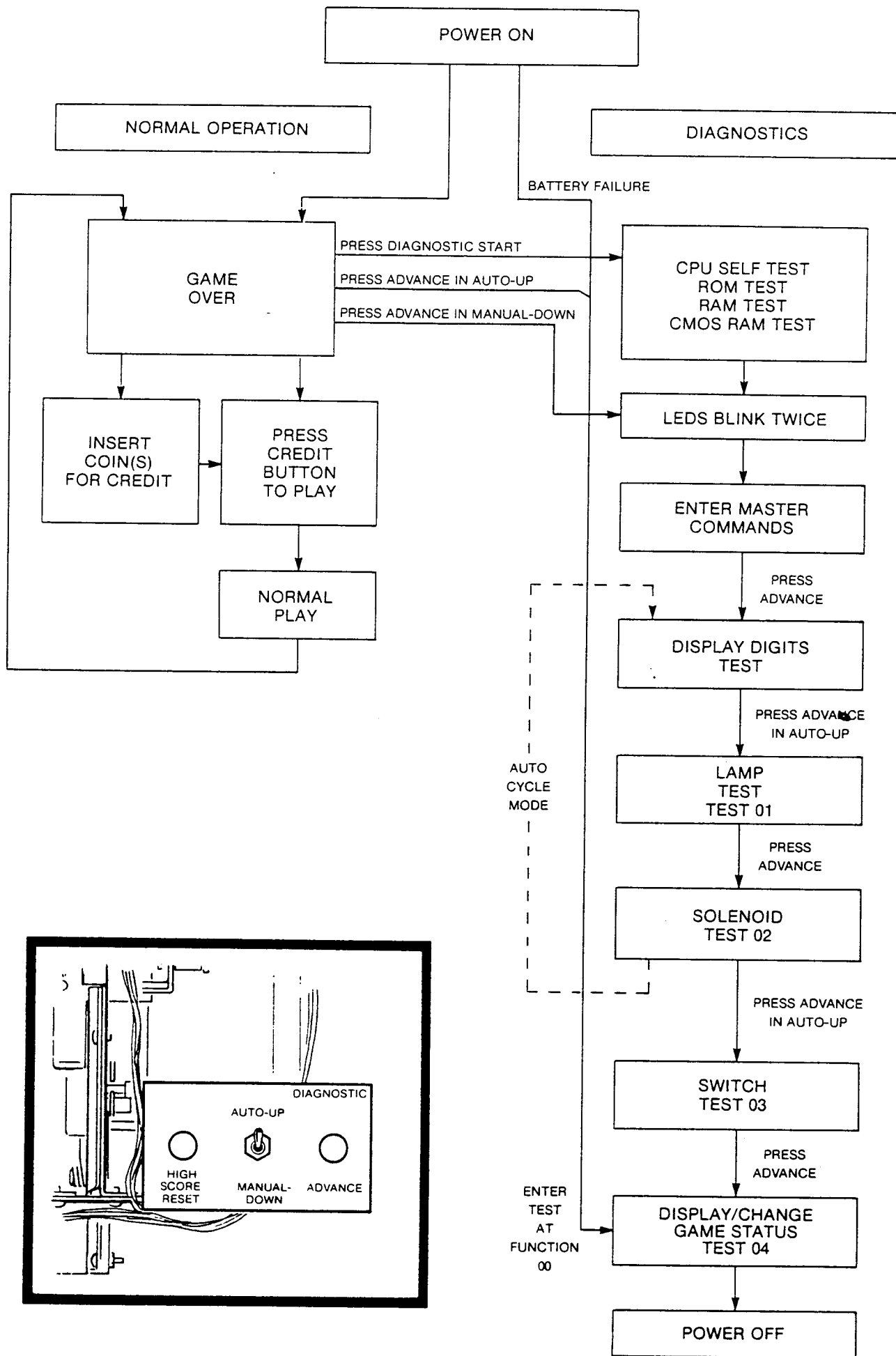

Figure 3. Normal Operation and Diagnostic Flow Chart

- a. From the Display Digits test, set the AUTO-UP/MANUAL-DOWN switch to AUTO-UP and momentarily depress the ADVANCE pushbutton.
- b. From the game over mode.
  - (1) Set the AUTO-UP/MANUAL-DOWN switch to MANUAL-DOWN and momentarily depress the ADVANCE pushbutton.
  - (2) Set the switch to AUTO-UP and operate the ADVANCE pushbutton until 01 is indicated on the number of credits display.

The multiplexed lights should blink on and off.

2. If no further tests are required, turn the game OFF and back ON to return to the game over mode.

#### Solenoid Test—Test 02

This test permits checking of all solenoids by causing the Driver Board to pulse each solenoid. Proceed as follows:

1. Enter the Solenoid Test in one of the following ways:
  - a. From the Display Digits or Lamp Test, set the AUTO-UP/MANUAL-DOWN switch to AUTO-UP and operate the ADVANCE pushbutton until 02 is indicated on the number of credits display.
  - b. From the game over mode,
    - (1) Set the AUTO-UP/MANUAL-DOWN switch to MANUAL-DOWN and momentarily depress the ADVANCE pushbutton.
    - (2) Set the switch to AUTO-UP and operate the ADVANCE pushbutton until 02 is indicated in the number of credits display.

The ball in play display should indicate each solenoid number as it is being pulsed.

2. To repeatedly pulse solenoids one at a time set the switch to MANUAL-DOWN and momentarily depress the ADVANCE pushbutton. The solenoid number indicated in the ball in play display should be pulsed repeatedly.
3. Each time the ADVANCE pushbutton is depressed, the next solenoid will be indicated in the ball in play display and will be pulsed.
4. If no further tests are required, turn the game OFF and back ON to return to the game over mode.

#### Switch Test—Test 03

This test permits checking of all multiplexed switches in the game. Proceed as follows:

1. Enter the Switch Test in one of the following ways:
  - a. From the Display Digits, Lamp, or Solenoid Tests, set the AUTO-UP/MANUAL-DOWN switch to AUTO-UP and operate the ADVANCE pushbutton until 03 is indicated on the number of credits display.
  - b. From the game over mode,
    - (1) Set the AUTO-UP/MANUAL-DOWN switch to MANUAL-DOWN and momentarily depress the ADVANCE pushbutton.
    - (2) Set the switch to AUTO-UP and operate the ADVANCE pushbutton until 03 is indicated on the number of credits display.

All stuck switches will be sequentially indicated on the ball in play display. If there are no stuck switches, the display will be blank.

2. Actuate each switch and check for the proper switch number on the ball in play display.

3. If it is desired to change game adjustment or review game status, refer to Section 3, Game Adjustments. Otherwise, turn the game OFF and back ON to return to the game over mode.

#### Auto Cycle Mode

This mode is provided to help diagnose intermittent problems by continuously performing the Display Digits, Lamps, and Solenoid Tests. Each cycle of this mode sequences through the display tests, flashes the lamps 64 times, and pulses each solenoid. This mode is initiated by using the coin door switches and two switches on the CPU Board. Refer to Figures 1 and 2 and proceed as follows:

1. **With the game in the game over mode**, set the AUTO-UP/MANUAL-DOWN switch to MANUAL-DOWN and momentarily depress the ADVANCE pushbutton. All displays should go blank.
2. Remove the backglass and unlatch and open the insert door.
3. Set all switches on the MASTER COMMAND slide switch to OFF (move to the right).
4. Set switch 6 to ON (move to the left).
5. Momentarily depress the MASTER COMMAND ENTER pushbutton. The LED's should blink once.
6. Set the AUTO-UP/MANUAL-DOWN switch to AUTO-UP and momentarily depress the ADVANCE pushbutton. The Auto Cycle mode should start with the display digits test.
7. To gain manual control during the Display Digits Test, momentarily depress the ADVANCE pushbutton with the toggle switch set to MANUAL-DOWN.
8. To return to the Auto Cycle mode, set the toggle switch to AUTO-UP and momentarily depress the ADVANCE pushbutton.
9. To gain manual control during the Solenoid test, momentarily depress the ADVANCE pushbutton with the toggle switch set to MANUAL-DOWN.
10. To return to the Auto Cycle mode, set the toggle switch to AUTO-UP.
11. To exit the Auto Cycle mode and advance to Switch Test 03, set the toggle switch to AUTO-UP and depress the ADVANCE pushbutton during the Solenoid Test. Operation is now as previously described for Test 03.
12. To terminate the Auto-Cycle mode and go to game over, turn the game OFF and back ON.

## SECTION 6 MAINTENANCE

This section provides procedures for board replacement, CPU and Sound Board self-tests, and troubleshooting procedures. For any problems first perform the CPU Board Self-Tests. For sound problems also perform the Sound Board Self-Test. After performing the self-test(s), refer to the troubleshooting charts that follow.

### Board Replacement

#### CPU Board

To remove the CPU Board, the Driver Board must first be unmounted. Revision level 6 CPU Boards are required for the memory protection feature. If a game ROM is used instead of PROMs, jumper J3 must be connected and J4

removed; if a game ROM and PROMs are used, J4 must be connected and J3 removed. Refer to the Foreword of the Game Manual for specific requirements if earlier CPU Boards must be used. To replace the CPU Board, proceed as follows:

1. Turn the game OFF.
2. Remove the six screws and star washers that secure the driver board to its mounting bracket.
3. Carefully unplug the Driver Board from the CPU Board.
4. Disconnect the seven plugs from the CPU Board.
5. Remove the two screws and star washers that secure the top of the CPU Board to its mounting bracket in the backbox. (The bottom of the board is secured by a groove in the bracket.)
6. Lift the CPU Board up and remove it from the backbox.
7. Inspect the PROMs and ROMs:
  - a. If the replacement board does not have proper PROMs or Game ROM, use the ICs from the old CPU board.
  - b. If the replacement board does not have green-labeled ROMs, use the ROMs from the old board.
8. For revision level 6 CPU Boards using a Game ROM, check that jumpers J3/J4 are connected as appropriate.
9. Set the replacement CPU Board into the groove in the bracket and secure it at the top with the two screws and star washers removed in step 5.
10. Reconnect the cables disconnected in step 4 using the keys and cut-off pins as a guide. Make sure that the pins are aligned, the connectors are firmly seated, and that no pin terminations have been pushed out of the plugs.
11. Carefully plug the Driver Board onto the CPU Board and mount the Driver Board to the bracket using the six screws and star washers removed in step 2.
12. Turn the game ON and perform the CPU Board Self-Test procedures.

#### Driver Board

Proceed as follows:

1. Turn the game OFF.
2. Disconnect the 12 plugs from the board.
3. Remove the six screws and star washers that secure the board to its mounting bracket.
4. Carefully unplug the Driver Board from the CPU Board and remove the Driver Board.
5. Align the replacement board over the pins on the CPU Board and carefully plug it onto the CPU Board.
6. Secure the board to the mounting bracket using the six screws and star washers removed in step 3.
7. Reconnect the cables disconnected in step 2 using the keys and cut-off pins as a guide. Make sure that the pins are aligned, the connectors are firmly seated, and that no pin terminations have been pushed out of the plugs.
8. Turn the game ON and perform Lamp, Solenoid, and Switch tests in accordance with procedures provided in Section 5.

#### Power Supply Board

Fuse F4 (10A SB or, for games with four flippers, 15A SB) for flipper solenoids must be installed on the replacement board. Proceed as follows:

1. Turn the game OFF.
2. Unplug the six cables from the board.
3. Remove the six screws and star washers that secure the board to its mounting bracket.
4. Position the replacement board on the mounting bracket and secure with the six screws and star washers removed in step 2.
5. Reconnect the six cables unplugged in step 2.
6. Turn the game ON and check power supply voltage using Table 3 as a guide.

#### Master Display Board

Proceed as follows:

1. Turn the game OFF.
2. Unplug the seven cables from the board.
3. Remove the four nuts and lockwashers that secure the board to the nylon spacers on the insert door and remove the board.
4. Position the replacement board on the spacers and secure it using the four nuts and lockwashers removed in step 3.
5. Reconnect the seven cables unplugged in step 2.
6. Turn the power ON and perform the display digits test in accordance with procedures provided in Section 5.

#### Slave Display Board

Proceed as follows:

1. Turn the game OFF.
2. Unplug the cable connected to the board.
3. Remove the four nuts and lockwashers that secure the board to the nylon spacers on the insert door and remove the board.
4. Position the replacement board on the spacers and secure it using the four nuts and lockwashers removed in step 3.
5. Reconnect the cable unplugged in step 3.
6. Turn the game ON and perform display digits test in accordance with procedures provided in Section 5.

#### Sound Board

When replacing the Sound Board, the replacement board must be a D8224 Sound Board, have the proper PROM or ROM installed, and be jumpered appropriately. Proceed as follows:

1. Turn the game OFF.
2. Unplug the four or five cables from the Sound Board.
3. Remove the four screws and star washers that secure the board to its mounting bracket and remove the board.
4. If the replacement board is not equipped with the proper PROM or ROM, use the IC from the old board.
5. Refer to Figure 4 and check the jumpers on the replacement board. If it is not jumpered appropriately, jumper as required.

Table 3. Typical Voltage Measurements

VOLTAGE	METER SETTING	MEASURE ACROSS	TYPICAL READING
Unregulated Logic Supply	+50V dc	(+) F5 (-) Ground	+11V dc
Logic B+	+10V dc	(+) 3J6-7 (Gray Lead) (-) Ground	+5.1V dc
Lamp Supply	+50V dc	(+) F3 (-) Ground	+18V dc
Solenoid Supply	+50V dc	(+) F2 (-) Ground	+40V dc
Display Voltage	+250V dc	(+) 3J5-4 (Brown-White lead) (-) Ground	+100V dc
	-250V dc	(+) 3J5-3 (Orange and White- Black Leads) (-) Ground	-100V dc
General Illumination	10V ac	(+) Fuse Card Fuse (-) Fuse Card Terminal	6.3V ac

6. Position the replacement board on its mounting bracket and secure with the four screws and star washers removed in step 3.
7. Reconnect the cables unplugged in step 2.
8. Set option switches as follows:
  - a. If optional Speech Module is provided, set switch 2 to ON for speech.
  - b. Set option switch 1 to ON or OFF to select synthesized sounds or musical notes as appropriate.
9. Turn the game ON and perform the Sound Board and Speech Module Self-Test or the Sound Board Self-Test as appropriate.

#### Optional Speech Module

When replacing the Speech Module, either the C 8226 or C 8228 board may be used as long as it is equipped with the proper ROMs as indicated in the Game Manual. Proceed as follows:

1. Turn the game OFF.
2. Unplug the Speech Module interconnect cable from the Sound Board.
3. Remove the four screws and star washers that secure the board to its mounting bracket and remove the board.
4. If the replacement board is not equipped with the proper ROMs, use the ICs from the old board.
5. Position the replacement board in its mounting bracket and secure with the four screws and lockwashers removed in step 3.
6. Plug the interconnect cable into the Sound Board.
7. Turn the game ON and perform the Sound Board and Speech Module Self-Test.

#### CPU Board Self-Test

A pushbutton switch on the CPU board is used to initiate the CPU Board Self-Test. **The coin door must be open to perform this test.** Successful completion of the test is indicated by the LEDs blinking twice. Failure of a test is indicated by one or both of the LEDs lighting and staying lit. Proceed as follows:

1. Open the coin door.

#### NOTE

Should step 2 be performed with the coin door closed, both LEDs will stay on. This results in audit totals being zeroed and, unless the following action is taken, game adjustments will revert to factory settings. Turn the game OFF and ON twice. Next, open the coin door and proceed with step 2.

2. With the game turned ON, locate the DIAGNOSTIC pushbutton on the right side of the CPU board.
3. Momentarily depress the DIAGNOSTIC pushbutton. The LEDs should blink twice and all displays should go blank.
4. For the following indications of the LEDs, proceed as follows:

OFF  Indicates ROM/PROM failure; one or more of IC17, IC20, IC21, IC22, and IC26 are faulty. Isolate the faulty chip(s) by substitution.

ON  Indicates RAM failure (IC13 or IC16), replace the CPU Board.

ON  Indicates CMOS RAM (IC19) failure. Replace the CPU Board.

5. If the LEDs come on and stay on when the game is first turned ON or the LEDs remain off when the DIAGNOSTIC pushbutton is depressed, refer to Table 12 in the troubleshooting charts that follow.

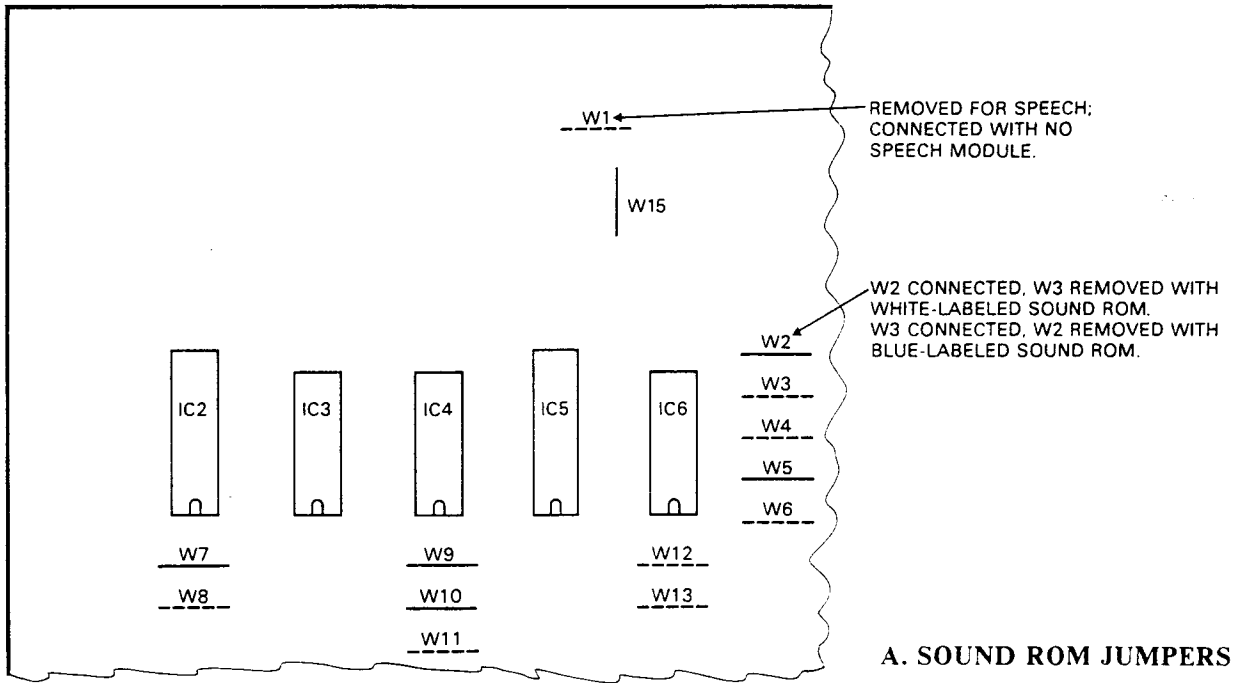

A. SOUND ROM JUMPERS

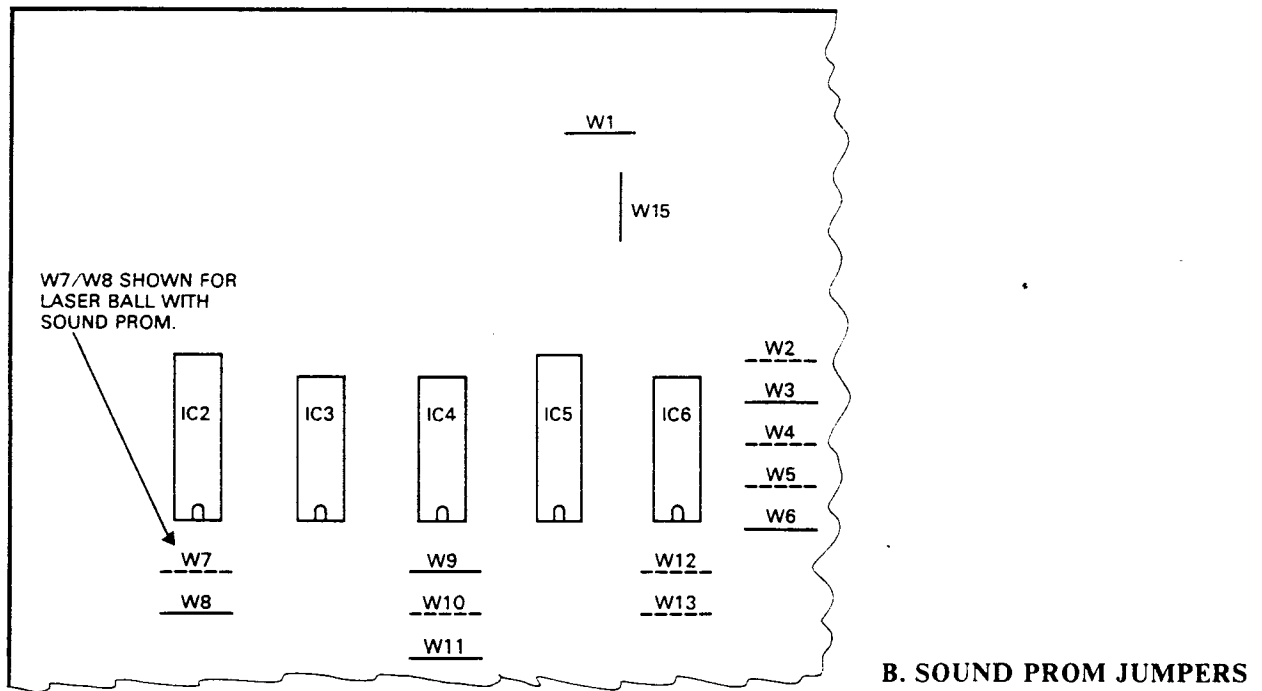

B. SOUND PROM JUMPERS

JUMPER CONNECTION CHART

APPLICATIONS	JUMPERS (X = connected, O = removed)											
	W2	W3	W4	W5	W6	W7	W8	W9	W10	W11	W12	W13
2K ROMs (White Labels)	X	O	O	X	O	X	O	X	X	O	O	O
4K ROMs (Blue Labels)	O	X	O	X	O	X	O	X	X	O	O	O
Laser Ball with Sound PROM	O	X	X	O	X	O	X	O	O	X	X	O
Later Sound PROMs	O	X	X	O	X	O	X	O	O	X	X	O

Notes:

1. Jumper W1 must be connected on games without Speech Module. It must be removed for speech.
2. Jumper W15 always connected.

Figure 4. Sound Board Jumper Details

### Sound Board and Speech Module Self-Tests

Depressing the Diagnostic pushbutton switch on the Sound Board initiates the self-tests. The test first checks the contents of Sound ROM (IC12). If the chip passes its test the test proceeds to produce several sounds from IC12 Sound ROM and then produces speech from the ROMs on the Speech Module. The cycle just described is then repeated from the test of IC12. To stop the self-test the game must be turned OFF and ON. For the self-test proceed as follows:

1. Perform the CPU Board Self-Test.
2. Momentarily depress the diagnostic pushbutton on the Sound Board.
3. If no sounds are produced;
  - a. Turn the game OFF, disconnect the Speech Module cable from the Sound Board, and connect a jumper from 10J4 pin 1 to the negative (-) terminal of C29.
  - b. Turn the game back ON and momentarily depress the Diagnostic pushbutton on the Sound Board. If Sounds are now produced, refer to Table 13 for faulty Speech Module.
  - c. If no sounds are produced, check volume control in cabinet and connections to it. Refer to Table 13 for faulty Sound Board.
4. If only electronic sounds are produced with silent intervals;
  - a. Check setting of balance control on Speech Module.
  - b. Refer to Table 13 and troubleshoot for faulty Sound Board or Speech Module.
5. If only electronic sounds are produced without silent intervals refer to Table 13 and troubleshoot for faulty Sound Board or Speech Module.
6. If only speech and is produced;
  - a. Isolate Sound Board as in 3. a., turn game back ON and momentarily depress diagnostic pushbutton on Sound Board.
  - b. If the electronic sounds are now produced check Sound Analog connection to Speech Module and check R8, R12, and R16 on Speech Module. If no other sounds are produced, refer to Table 13 for faulty Sound Board.
7. If sounds are produced properly but one or more sounds are missing in Solenoid Test 02, refer to Table 14.

### Sound Board Self-Test

When a Sound ROM is used, depressing the diagnostic pushbutton causes a check of the IC12 ROM. If the chip passes its test the test proceeds to produce several electronic sounds. The cycle just described is then repeated from the test of IC12. For games using a sound PROM, a similar sequence is performed. To terminate the Self-Test, the game must be turned OFF and back ON.

1. Perform the CPU Board Self-Test.
2. Momentarily depress the diagnostic pushbutton switch on the Sound Board.
3. If no sounds are produced, check the volume control and connections to it. Refer to Table 15.
4. If sounds are produced but one or more sounds are missing in Solenoid Test 02, refer to Table 14.

### Troubleshooting Charts

Tables 4 through 12 are used in conjunction with the diagnostic test described in Section 5 to isolate problems and repair faulty games. For specific problems with:

Game Operation—See Table 4

Switches—See Table 5

Solenoids—See Table 6

Lamps—See Table 7

Game does not operate or blows fuses—See Table 8

Master Display—See Table 9

Player Display—See Table 10

Losing memory—See Table 11

No response to CPU Self-Tests or intermittent operation  
See Table 12

Troubleshooting procedures provided in Tables 13, 14, and 15 are to be used with Sound Board/Speech Module Self-Tests described in Section 5. For certain types of problems, use of Solenoid Test 02 is also necessary. Before troubleshooting, perform the Self-Tests. The Self-Test procedures provide a guide for use of the troubleshooting procedures.

A multimeter and a pulse-stretching logic probe are required for fault isolation. When the procedures require checking for activity, use of the logic probe provides the better indication. However, checking for meter deflection with the multimeter set for AC voltage, should give an indication of activity. When required to check for the occurrence of a pulse, the logic probe is required.

Table 4. Game Operation and Adjustments

GAME OPERATION	ADJUSTMENTS	
1. Play game manually to verify problem. 2. Review Section 2, Game Operation. 3. Place in Diagnostics Test 04; review and change game adjustments to that desired.	<b>No Control from Coin Door Diagnostic Switches</b> 1. Check cabling for the switches in 7P1, 7P2, and 1P4. 2. Check for stuck Credit button switch. 3. Replace CPU Board.	<b>Unable to Adjust Setting</b> 1. Check for open Credit button switch 2. Replace CPU Board.

Table 5. Switches  
(Place Diagnostics in Test 03)

1 SWITCH	4-8 SWITCHES		ALL SWITCHES
<p><b>Always Actuated</b></p> <ol style="list-style-type: none"> <li>1. Check contacts</li> <li>2. Check shorted wires</li> </ol> <p><b>Never Actuates</b></p> <ol style="list-style-type: none"> <li>1. Check adjustment</li> <li>2. Check broken wires</li> <li>3. Check for open diode by jumpering across diode and actuating.</li> </ol>	<p><b>Always Actuated</b></p> <ol style="list-style-type: none"> <li>1. Check adjustments</li> <li>2. Check shorted wires on playfield or to 2J2, 2J3</li> <li>3. Replace Driver Board</li> </ol> <p><b>Never Actuated</b></p> <ol style="list-style-type: none"> <li>1. Check adjustment</li> <li>2. Check broken wires on playfield or 2J2, 2J3</li> <li>3. Check plug 8P1/8J1 for broken wires or pushed out pins</li> <li>4. Replace Driver Board</li> </ol>	<p><b>Switch Closure Displays Multiple Switch Numbers</b></p> <ol style="list-style-type: none"> <li>1. Check adjustments</li> <li>2. Check shorted wires on playfield or to 2J2, 2J3</li> <li>3. Replace Driver Board</li> </ol> <p><b>Switch Displays Incorrect No.</b></p> <ol style="list-style-type: none"> <li>1. Check correct switch chart for game and check adjustment</li> <li>2. Incorrect wiring on playfield 2J2, 2J3, or 8P1/8J1</li> <li>3. Check Connector keying</li> </ol>	<ol style="list-style-type: none"> <li>1. Check adjustments</li> <li>2. Check Connectors 2J2, 2J3, are not exchanged</li> <li>3. Replace Driver Board</li> </ol>

Table 6. Solenoids  
(Place Diagnostics in Test 02)

1 SOLENOID		ALL SOLENOIDS
<p><b>Never Actuates</b></p> <ol style="list-style-type: none"> <li>1. Check solenoid Chart to verify number correct and in use</li> <li>2. Broken wire to solenoid</li> <li>3. Shorted diode across solenoid</li> <li>4. Shorted/burned out solenoid</li> <li>5. Open driver for that solenoid—replace Driver Board</li> </ol>	<p><b>Always Actuated</b></p> <ol style="list-style-type: none"> <li>1. Shorted wire for that solenoid</li> <li>2. Shorted driver for that solenoid on Driver Board—replace Driver Board</li> </ol>	<p><b>Never Actuated</b></p> <ol style="list-style-type: none"> <li>1. Check for +28 VDC on Power Supply fuse 3F2 to ground</li> <li>2. Check fuse 3F2 on Power Supply</li> <li>3. Check Connectors 3J3 and 3J4 on Power Supply</li> <li>4. Check Connector 2J9, 2J10, 2J11, 2J12 for broken/shorted wires.</li> <li>5. Replace Driver Board</li> </ol>
<b>FLIPPERS IN GENERAL</b>		
ONE FLIPPER	ALL FLIPPERS	
<p><b>Never Operates</b></p> <ol style="list-style-type: none"> <li>1. Switch contacts on flipper button open or out of adjustment.</li> <li>2. Shorted diode across coil.</li> </ol> <p><b>Flipper Weak</b></p> <ol style="list-style-type: none"> <li>1. Switch contacts on flipper button out of adjustment or pitted contacts.</li> <li>2. End of stroke switch on solenoid not adjusted properly.</li> <li>3. Check connections on solenoid and check for bind.</li> </ol>	<p><b>Never Operate</b></p> <ol style="list-style-type: none"> <li>1. Check Fuse 3F4 on Power Supply and 8P2 connection.</li> <li>2. Diode or resistor in driver circuit shorted.</li> <li>3. Relay 2Z1 on driver board faulty.</li> <li>4. Other fault in driver circuit. Replace driver board.</li> </ol> <p><b>Operates with Game Over, etc.</b></p> <ol style="list-style-type: none"> <li>1. Replace Driver Board</li> </ol>	
END-OF-STROKE ACTIVATED FLIPPER	DUAL-ACTION FLIPPER PAIR	
<p><b>Never Operates</b></p> <ol style="list-style-type: none"> <li>1. End-of-stroke switch contacts on actuating flipper open or out of adjustment.</li> <li>2. Check wiring from actuating flipper end-of-stroke switch to flipper coil.</li> <li>3. Shorted diode across coil.</li> </ol> <p><b>Flipper Weak</b></p> <ol style="list-style-type: none"> <li>1. End-of-stroke switch on actuating flipper out of adjustment or pitted contacts.</li> <li>2. End-of stroke switch on flipper not adjusted properly.</li> <li>3. Check connections on solenoid and check for bind.</li> </ol>	<p><b>Never Operates</b></p> <ol style="list-style-type: none"> <li>1. Check connectors from switches to backbox to Driver Board.</li> <li>2. Switch contacts on flipper button open or out of adjustment.</li> </ol>	



Table 7. Lamps  
(Place Diagnostics in Test 01)

1 LAMP	4-8 LAMPS	ALL LAMPS	GENERAL ILLUMI.
<p><b>Always OFF</b></p> <ol style="list-style-type: none"> <li>1. Check Bulb</li> <li>2. Check Diode (Observe Polarity)</li> <li>3. Check wiring (broken wires)</li> </ol> <p><b>Glows DIM</b></p> <ol style="list-style-type: none"> <li>1. Check Bulb (correct #bulb)</li> <li>2. Check Diode (Observe Polarity)</li> <li>3. Check wiring (shorted wires)</li> </ol> <p><b>Always ON</b></p> <ol style="list-style-type: none"> <li>1. Check Diode (Observe Polarity)</li> <li>2. Check wiring (shorted wires)</li> </ol>	<p><b>Always OFF</b></p> <ol style="list-style-type: none"> <li>1. Check wiring (broken wires)</li> <li>2. Check Connectors (2J5, 2J7)</li> <li>3. Replace Driver Board</li> </ol> <p><b>Glows DIM</b></p> <ol style="list-style-type: none"> <li>1. Check wiring (broken wires)</li> <li>2. Check Diode</li> <li>3. Check Connectors (2J5, 2J7)</li> <li>4. Replace Driver Board</li> </ol> <p><b>Always ON</b></p> <ol style="list-style-type: none"> <li>1. Check wiring (shorted wires)</li> <li>2. Check Diodes</li> <li>3. Check Connectors (2J5, 2J7)</li> <li>4. Replace Driver Board</li> </ol>	<p><b>Always OFF</b></p> <ol style="list-style-type: none"> <li>1. Check fuse 3F3 on Power Supply</li> <li>2. Check for +18 VDC on fuse 3F3 to ground</li> <li>3. Check Connector 3J4</li> <li>4. Check Connector 8P2/8J2</li> <li>5. Check wiring (broken or shorts)</li> <li>6. Replace Driver Board</li> </ol> <p><b>Glows DIM</b></p> <ol style="list-style-type: none"> <li>1. Check line voltage</li> <li>2. Check for +18 VDC on fuse 3F3 to ground</li> </ol>	<p><b>Always ON</b> Normal Condition</p> <p><b>Always OFF</b></p> <ol style="list-style-type: none"> <li>1. Check Fuse on Fuse Card</li> <li>2. Check for +6.3 VAC</li> <li>3. Check Connectors (3J3)</li> <li>4. Check Connectors 9P1 and 8P2/8J2</li> <li>5. Check wiring (broken or short)</li> </ol> <p><b>Glows DIM</b></p> <ol style="list-style-type: none"> <li>1. Check line voltage</li> </ol>
<p>All lamps are N44 or equivalent All diodes are 1N4001 or equivalent</p>			

Table 8. Inoperative or Blows Fuses

MACHINE INOPERATIVE		
<ol style="list-style-type: none"> <li>1. Remove plug from wall outlet and measure wall voltage.</li> <li>2. With machine unplugged, check the line fuse, line cord, and ON/OFF switch with an Ohmmeter for continuity.</li> <li>3. Check for any loose connections on line filter, ON/OFF switch.</li> <li>4. Check that power connector to transformer is securely connected.</li> <li>5. Check all fuses on power supply board.</li> <li>6. Plug machine in, turn on and check voltage on power supply board fuses.</li> </ol>		
MACHINE BLOWS FUSE		
<p><b>Wall Fuse or Circuit Breaker Fuse</b></p> <ol style="list-style-type: none"> <li>1. Disconnect wall plug.</li> <li>2. Disconnect connector from line filter to transformer.</li> <li>3. Check line cord with Ohmmeter for shorts.</li> <li>4. Check varistor and line filter for shorts.</li> <li>5. Plug cord in wall and see if wall fuse still blows - if yes, disconnect whatever else is on same wall plug circuit and repeat steps 3 and 4 above.</li> </ol>	<p><b>Machine Fuse</b></p> <ol style="list-style-type: none"> <li>1. Check for correct fuse rating.</li> <li>2. Check varistor, line filter, line cord for shorts.</li> <li>3. Disconnect connector from line filter to transformer and try another fuse.</li> <li>4. If fuse still blows, repeat steps 1-3.</li> <li>5. If fuse does not blow, disconnect 3P1 and 3P2 plugs from the power supply board and reconnect plug from line filter to transformer.</li> <li>6. If fuse blows, check transformer and both lamps and solenoid rectifiers for shorts.</li> <li>7. If fuse does not blow, plug in 3P2 and 3P1 then try again. If fuse now blows, disconnect 3P3, 3P4, 3P5, 3P6, and try another fuse. If fuse still blows replace Power Supply.</li> <li>8. If fuse doesn't blow, hook up 3P3, 3P4, 3P5, and 3P6 one at a time. If fuse blows when any one is plugged, look for burned out solenoid, dead shorts, etc.</li> </ol>	<p><b>Individual Power Supply Fuse</b></p> <ol style="list-style-type: none"> <li>1. Disconnect load from portion of the power supply that blows the fuse by disconnecting the appropriate plug. <ol style="list-style-type: none"> <li>a. 3F1 (+100 VDC, -100 VDC) disconnect 3P5</li> <li>b. 3F2 (+28 VDC) disconnect 3P4, 3P3</li> <li>c. 3F4 (Flipper +28 VDC) disconnect 3P3</li> <li>d. 3F3 (+18 VDC) disconnect 3P4</li> <li>e. 6F1 (6.3 VAC) disconnect 7P1, 8P2, 9P1.</li> <li>f. 3F5, 6F2, or 6F3 (+5 VDC) disconnect 3P6, 3P5</li> </ol> </li> <li>2. If fuse still blows, replace Power Supply.</li> <li>3. If fuse does not blow, check for shorts in wiring, burned out solenoids, etc.</li> </ol>

Table 9. Master Display  
(Place Diagnostics in Display Digits Test)

USE EXTREME CAUTION WHEN MEASURING HIGH VOLTAGES!!!	
NO DISPLAY	INCORRECT DISPLAY
<ol style="list-style-type: none"> <li>1. Check -100 VDC, +100 VDC &amp; fuse 3F1 on Power Supply.</li> <li>2. Check connectors 3J5, 4J7, 4J5, 1J3, 1J5, 1J6, 1J7</li> <li>3. Check for +100 VDC and -100 VDC on connector 4J7—replace Power Supply Board if voltage incorrect</li> <li>4. Replace Master Display Board.</li> </ol>	<ol style="list-style-type: none"> <li>1. Check +100 VDC, -100 VDC at 4J7</li> <li>2. Check for broken or shorted wires on 4J5, 4J6, 1J5, 1J6, 1J7</li> <li>3. Replace Master Display Board</li> </ol>

Table 10. Player Display  
(Place Diagnostics in Display Digits Test)

USE EXTREME CAUTION WHEN MEASURING HIGH VOLTAGES!!!	
1 PLAYER DISPLAY INCORRECT/OFF	2-4 PLAYER DISPLAYS INCORRECT/OFF
<ol style="list-style-type: none"> <li>1. Check correct location of connector from Master Display Board.</li> <li>2. Replace Player Display—if still incorrect, replace Master Display Board.</li> </ol>	<ol style="list-style-type: none"> <li>1. Check correct location of connectors from Master Display Board</li> <li>2. Check voltage +100 VDC and -100 VDC on connector 4J7</li> <li>3. If voltages are correct—replace Master Display Board.</li> </ol>

Table 11. Losing Memory

GAME COMES UP IN TEST 04 WHEN TURNED ON	GAME GOES TO DIAGNOSTICS FROM GAME OVER OR DURING PLAY
<ol style="list-style-type: none"> <li>1. Check that the batteries are properly seated.</li> <li>2. Turn game OFF and wait 30 seconds.</li> <li>3. Check battery voltage from the anode of 1D17 to ground. If less than 3.9 VDC, replace the batteries.</li> <li>4. Check battery voltage from cathode of 1D17 to ground. If less than 3.2 VDC, replace diode and recheck voltage.</li> <li>5. Replace CPU Board.</li> </ol>	<p>Perform procedures for intermittent operation provided in Table 12.</p>

Table 12. No Response to CPU Self-Test or Intermittent Operation

LEDs REMAIN ON AFTER POWER TURN-ON	LEDs DO NOT FLASH AND REMAIN OFF WHEN DIAGNOSTIC SWITCH DEPRESSED	INTERMITTENT OPERATION
<ol style="list-style-type: none"> <li>1. Check +5 VDC and Unregulated Logic B+ on CPU and Power Supply Boards. (See Table 4.) If low: <ol style="list-style-type: none"> <li>a. Check ac input from transformer.</li> <li>b. Check wiring from transformer to 3P1-10, -11, and -12.</li> <li>c. Check 3D6 and 3D7.</li> <li>d. Replace Power Supply Board.</li> </ol> </li> <li>2. Turn game OFF and completely remove Driver Board from the backbox. Reapply power and depress the DIAGNOSTIC push-button on the CPU Board. If the LEDs blink twice and then remain OFF, replace the Driver Board. Otherwise, replace the CPU Board.</li> </ol>	<ol style="list-style-type: none"> <li>1. Turn game OFF and back ON.</li> <li>2. If problems persist, check +5 VDC from power supply. If ok, replace CPU Board.</li> </ol>	<ol style="list-style-type: none"> <li>1. Make checks described in step 1 for LEDs remaining on after power turn-on.</li> <li>2. Replace CPU Board.</li> </ol>

Table 13. Sound Problems on Games with Speech Module Option

SYMPTOM	CHECK	INDICATION/ACTION
<b>FAULTY SOUND BOARD OR SPEECH MODULE</b>		
Only electronic sounds with interval are produced.	1. Check that jumper W1 on Sound Board is removed and check setting of balance control on Speech Module. 2. Check for Speech Data activity: a. Sound Board IC10 pin 39 *b. Speech Module IC1 pin 12 (13)  3. Check for Speech Clock activity: a. Sound Board IC10 pin 19 *b. Speech Module IC1 pin 9 (14) 4. Check for audio from Speech Module *IC1 pin 3 (2)  5. Check for audio from Speech Module IC3 pin 7  *First pin no. for C 8228 Speech Module; no. in parentheses for C 8226	1. —  2. a. Activity at both pins, proceed. b. Activity at PIA none on Speech Module; check plating and connections c. No activity; IC9 on Sound Board or IC2 on Speech Module faulty. 3. Same as 2  4. a. 300 mVrms ac typical, proceed. b. No ac; IC1 or associated circuitry faulty. 5. a. 2 Vrms ac typical. C4, C12, R8, R12, or R13 faulty. Repair or replace. b. No audio. IC3 or associated circuitry faulty. Repair or replace.
Only electronic sounds without interval are produced.	1. Using logic probe check for negative "D" and "B" Address Select pulses after last sound: a. Sound Board IC2 pin 6 ("D") and pin 4 ("B") b. Speech Module IC6 pin 20 ("D") and IC7 pin 20 ("B")  2. Disconnect Speech Module cable and check for pulse at Sound Board IC2 pin 6	1. a. All pulses occur. Replace Speech Module IC7. b. "D" Pulse or "B" pulse at Sound Board only; Check plating and connections c. No "B" pulse; Speech Module IC6 or IC7 or Sound Board IC2 faulty. Repair or replace. d. No "D" pulse; proceed. 2. a. Pulse, replace IC6 on Speech Module b. No pulse, replace IC2 on Sound Board
Some words replaced by noise.	Check for pulsing of "C" Address select: a. Sound Board IC2 pin 5 b. Speech Module IC5 pin 20	a. Pulsing at Sound Board IC2 only; check plating and connections. b. No pulsing; Sound Board IC2 or Speech Module IC5 faulty. Repair or Replace. c. Pulses at both chips; Speech Module IC5, IC6, or IC7 faulty.
<b>FAULTY SPEECH MODULE</b>		
Some words garbled.	—	Substitute new chips on Speech Module one at a time for IC5, IC6, and IC7.
Sounds produced after Speech Module disconnected in accordance with Diagnostic Procedure	1. Remove IC5, IC6, and IC7 from Speech Module. Reconnect module and remove test lead connected to Sound Board in Diagnostic procedures. Repeat self-test. 2. Replace chips removed in step 1 one at a time, repeating the self-test.	1. a. Sounds produced, proceed. b. No sounds, replace Speech Module.  2. Chip(s) which cause no sounds faulty.

TABLE CONTINUED ON NEXT PAGE

Table 13. Sound Problems on Games with Speech Module Option (con't)

SYMPTOM	CHECK	INDICATION/ACTION
FAULTY SOUND BOARD		
Only speech produced	—	IC12, IC10, IC13, or Q2 faulty.
No sounds produced after speech module disconnected in accordance with diagnostic procedure.	<ol style="list-style-type: none"> <li>1. a. Disconnect 10P4. b. Short pins 1 and 2 of board connector with fingers and listen for low-level hum from speaker.</li> <li>2. Check +5V, +12V, and -12V.</li> <li>3. Check Q3 collector voltage.</li> <li>4. Check for activity at IC9 pin 37.</li> </ol>	<ol style="list-style-type: none"> <li>1. a. Hum produced, proceed. b. No hum, check speaker connection, and IC1 and associated circuitry.</li> <li>2. —</li> <li>3. a. +5V; proceed. b. 0V; Q3, Q4, or associated circuitry faulty.</li> <li>4. a. No activity Y1 or IC9 faulty. b. Activity. Substitute new plug-in chips or replace sound board.</li> </ol>

Table 14. Solenoid Test Sound Troubleshooting

SYMPTOM	CHECK
Functions properly in Self-Test but one or more sounds missing in solenoid test.	<ol style="list-style-type: none"> <li>1. Check connection at 10P3 and 2P9.</li> <li>2. Replace ROM or PROM</li> <li>3. Check for pulse from Driver Board, replace driver if pulse missing</li> <li>4. Check for pulse from Sound Board buffer; replace buffer if pulse missing</li> <li>5. Check for pulses from IC6 output; replace IC6 if any pulses are missing.</li> <li>6. Replace Sound Board</li> </ol>
Functions properly in Self-Test, but all sounds are missing in solenoid test.	<ol style="list-style-type: none"> <li>1. Check connectors 10P13 and 2P9.</li> <li>2. Replace ROM or PROM</li> <li>3. Remove connector 10P3 and momentarily ground one of the used pins at 10J3. If a sound is produced a solenoid driver transistor is stuck on. Repair or replace Driver Board</li> <li>4. Check that buffers are not stuck low that IC6 output is not stuck high. Replace faulty chip</li> <li>5. Replace Sound Board</li> </ol>

Table 15. Troubleshooting Games without Speech Module Option  
No Sounds Produced in Self-Test

CHECK	INDICATION/ACTION
<ol style="list-style-type: none"> <li>1. Check +5V, +12V, and -12V</li> <li>2. a. Disconnect 10P4. b. Short pins 1 and 2 of board connector with fingers and listen for low-level hum.</li> <li>3. Check Q3 collector voltage.</li> <li>4. Check for activity at IC10 Pin 37.</li> </ol>	<ol style="list-style-type: none"> <li>1. —</li> <li>2. a. Hum produced; proceed. b. No hum, check speaker connections and IC1 and associated circuitry.</li> <li>3. a. +5V; proceed. b. 0V, Q3, Q4 or associated circuitry faulty.</li> <li>4. a. No activity; Y1 or IC10 faulty. b. Activity. Substitute new plug in chips or replace Sound Board.</li> </ol>

## SECTION 7 INTERCONNECTION CHARTS

The following interconnection charts are used to identify the color and pin number of all the wires for all the components. The following conventions are used throughout—

1. J1 is connector J1 on board 1.  
3J6 is connector J6 on board 3.
2. J designations refer to the male part of plug.  
P designations refer to the female part of plug.
3. The prefix numbers are as follows:
  1. CPU Board
  2. Driver Board
  3. Power Supply Board
  4. Master Display Board
  5. Slave Display Board
  6. Back Box Miscellaneous
  7. Cabinet
  8. Playfield
  9. Insert Board
  10. Sound Board
  11. Not Assigned
  12. Optional Speech Module

Refer to Table 15 for solenoid connections. Figure 12 provides identification of connectors used in the game.

Table 16. Solenoid Connections

SOL. NO.	WIRE COLOR	CONNECTIONS	DRIVER TRANS.
01	GRY-BRN	P11-4, 8P3-17	Q15
02	GRY-RED	2P11-5, 8P3-18	Q17
03	GRY-ORN	2P11-7, 8P3-19	Q19
04	GRY-YEL	2P11-8, 8P3-20	Q21
05	GRY-GRN	2P11-9, 8P3-21	Q23
06	GRY-BLU	2P11-3, 8P3-22	Q25
07	GRY-VIO	2P11-2, 8P3-23	Q27
08	GRY-BLK	2P11-1, 8P3-24	Q29
09	BRN-BLK	2P9-9, 10P3-3	Q31
10	BRN-RED	2P9-7, 10P3-2	Q33
11	BRN-ORN	2P9-1, 10P3-5	Q35
12	BRN-YEL	2P9-2, 10P3-4	Q37
13	BRN-GRN	2P9-3, 10P3-7	Q39
14	BRN-BLU	2P9-4, 7P1-16	Q41
15	BRN-VIO	2P9-5, 7P1-17	Q43
16	BRN-GRY	2P9-6, 7P1-18, 7P2-4	Q45
*17	BLU-BRN	2P12-7, 8P3-11	Q2
*18	BLU-RED	2P12-4, 8P3-12	Q4
*19	BLU-ORN	2P12-3, 8P3-13	Q6
*20	BLU-YEL	2P12-6, 8P3-14	Q8
*21	BLU-GRN	2P12-8, 8P3-15	Q10
*22	BLU-BLK	2P12-9, 8P3-16	Q12

### \*NOTES:

1. Special switch connections for solenoids 17 through 22 are as follows:
  - 17 – ORN-BRN – 2P13-5, 8P3-5
  - 18 – ORN-RED – 2P13-3, 8P3-6
  - 19 – ORN-BLK – 2P13-2, 8P3-7
  - 20 – ORN-YEL – 2P13-4, 8P3-8
  - 21 – ORN-GRN – 2P13-8, 8P3-9
  - 22 – ORN-BLU – 2P13-9, 8P3-10
2. Solenoid 15 may be used on playfield or may drive lamps on Insert Board. BRN-VIO wire is then connected to 6P2, 8P3-14, or 9P6-2.
3. Typical wiring for solenoids and special switches:

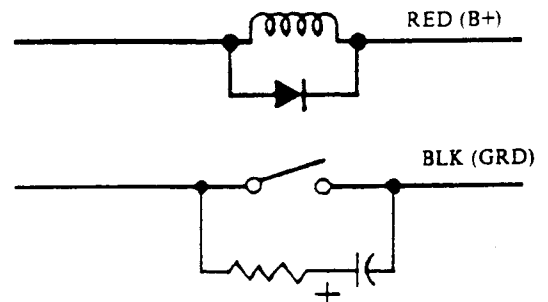

MALE CONNECTORS AND FEMALE RECEPTACLES  
 (UNLESS SPECIFIED OTHERWISE ALL CONNECTOR HOUSINGS ARE WHITE)

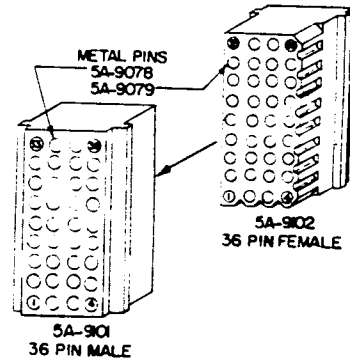
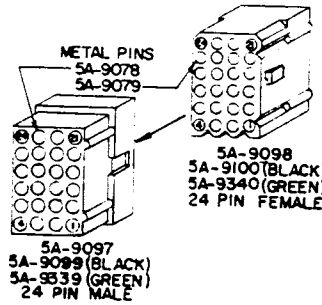
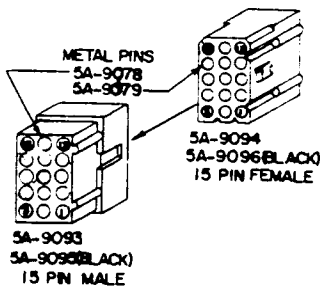
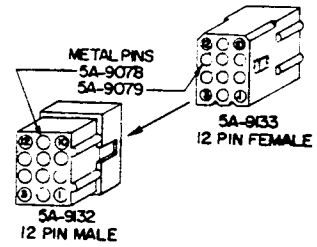
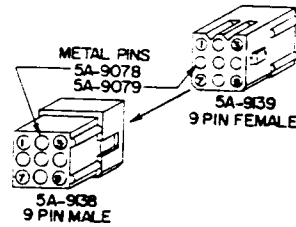
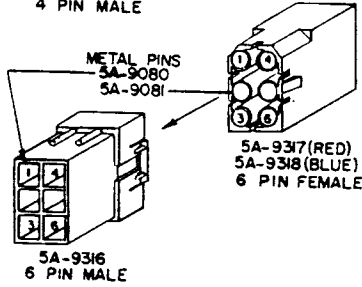
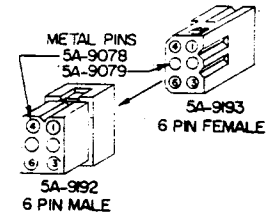
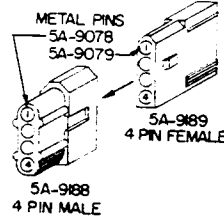
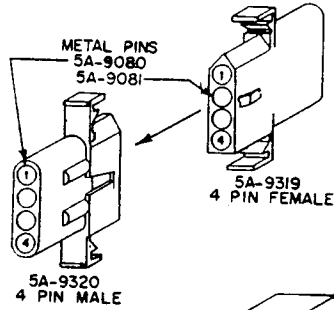
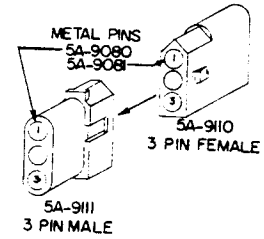
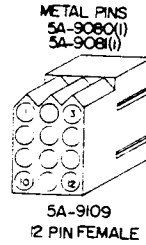
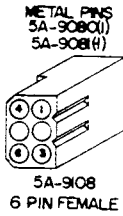
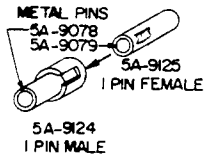
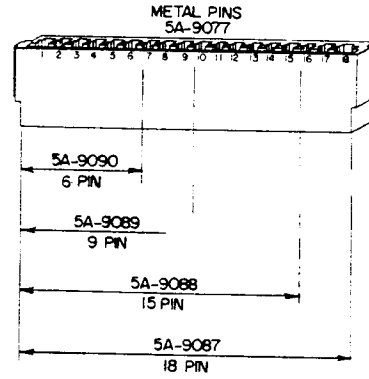
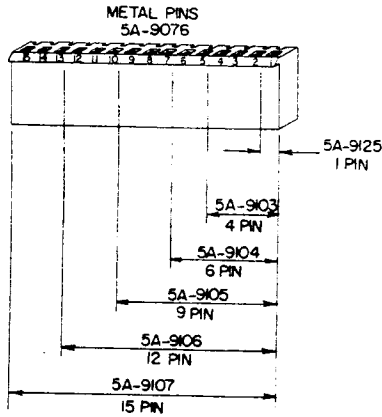

**CPU BOARD**

Pin	Wire Color	Function
<b>1J1 - INTERBOARD CONNECTOR</b>		
<b>1P2 - LOGIC POWER BUS INPUT</b>		
1	Black	Logic Ground
2	Black	Logic Ground
3	Black	Logic Ground
4	Gray	Logic B+ (+5 VDC)
5	Gray	Logic B+ (+5 VDC)
6	Gray	Logic B+ (+5 VDC)
7	Key	Key
8	N/C	Not Used
9	Gray-White	Logic B+ (+12 V Unregulated)
<b>1P3 - DISPLAY BLANKING</b>		
1	N/C	Not Used
2	N/C	Not Used
3	Key	Key
4	Blue-White	Display Blanking
<b>1P4 - DIAGNOSTIC SWITCH INPUTS</b>		
1	Black-Red	Memory Protect Interlock
2	White	Diagnostic Common
3	Green	Diagnostic Advance
4	Blue	Diagnostic Auto/Man.
<b>1P5 - MASTER DISPLAY BCD OUTPUTS</b>		
1	Blue-Yellow	Display BCD D1
2	Blue-Orange	Display BCD C1
3	Blue-Red	Display BCD B1
4	Blue-Brown	Display BCD A1
5	Blue-Gray	Display BCD D2
6	Key	Key
7	Blue-Violet	Display BCD C2
8	Blue-Black	Display BCD B2
9	Blue-Green	Display BCD A2
<b>1P6 - MASTER DISPLAY STROBE OUTPUTS</b>		
1	Violet-Gray	Display Strobe #16
2	Violet-Black	Display Strobe #15
3	Violet-Blue	Display Strobe #14
4	Violet-Green	Display Strobe #13
5	Violet-Yellow	Display Strobe #12
6	Violet-Orange	Display Strobe #11
7	Key	Key
8	Violet-Red	Display Strobe #10
9	Violet-Brown	Display Strobe # 9
<b>1P7 - MASTER DISPLAY STROBE OUTPUTS</b>		
1	Brown-Gray	Display Strobe #8
2	Brown-Violet	Display Strobe #7
3	Brown-Blue	Display Strobe #6
4	Brown-Green	Display Strobe #5
5	Brown-Yellow	Display Strobe #4
6	Brown-Orange	Display Strobe #3
7	Brown-Red	Display Strobe #2
8	Key	Key
9	Brown-Black	Display Strobe #1

**DRIVER BOARD**

Pin	Wire Color	Function
<b>2P1 - INTERBOARD CONNECTOR</b>		
<b>*2P2 - SWITCH COLUMN DRIVE</b>		
1	Green-Gray	Switch Column #8
2	Green-Violet	Switch Column #7
3	Green-Blue	Switch Column #6
4	Key	Key
5	Green-Black	Switch Column #5
6	Green-Yellow	Switch Column #4
7	Green-Orange	Switch Column #3
8	Green-Red	Switch Column #2
9	Green-Brown	Switch Column #1
<b>2P3 - SWITCH ROW INPUTS</b>		
1	White-Gray	Switch Row #8
2	Key	Key
3	White-Violet	Switch Row #7
4	White-Blue	Switch Row #6
5	White-Green	Switch Row #5
6	White-Yellow	Switch Row #4
7	White-Orange	Switch Row #3
8	White-Red	Switch Row #2
9	White-Brown	Switch Row #1
<b>2P4 - LAMP POWER BUS</b>		
1	Blue	Lamp B+
2	Blue	Lamp B+
3	Key	Key
4	Blue	Lamp B+
5	Blue	Lamp B+
6	N/C	Not Used
7	Blue	Lamp B+
8	Blue	Lamp B+
9	Blue	Lamp B+
<b>2P5 - LAMP COLUMN DRIVE</b>		
1	Yellow Violet	Lamp Column #7
2	Yellow Gray	Lamp Column #8
3	Yellow Green	Lamp Column #5
4	Key	Key
5	Yellow-Blue	Lamp Column #6
6	Yellow-Orange	Lamp Column #3
7	Yellow-Black	Lamp Column #4
8	Yellow-Brown	Lamp Column #1
9	Yellow-Red	Lamp Column #2
<b>2P6 - LAMP GROUNDS</b>		
1	Black	Lamp Ground
2	Key	Key
3	Black	Lamp Ground
4	Black	Lamp Ground
5	N/C	Not Used
6	Black	Lamp Ground
7	Black	Lamp Ground
8	Black	Lamp Ground
9	Black	Lamp Ground

\*All Switch columns are not always used.

**DRIVER BOARD (con't)**

Pin	Wire Color	Function
<b>2P7 - LAMP ROW DRIVE</b>		
1	Red-Brown	Lamp Row #1
2	Red-Black	Lamp Row #2
3	Red-Orange	Lamp Row #3
4	Red-Yellow	Lamp Row #4
5	Red-Green	Lamp Row #5
6	Red-Blue	Lamp Row #6
7	Key	Key
8	Red-Gray	Lamp Row #8
9	Red-Violet	Lamp Row #7

**2P8 - LOGIC POWER BUS INPUT**

1	Black	Logic Ground
2	Black	Logic Ground
3	Black	Logic Ground
4	Black	Logic Ground
5	Key	Key
6	Gray	Logic B+ (+5 VDC)
7	Gray	Logic B+ (+5 VDC)
8	Gray	Logic B+ (+5 VDC)
9	Gray	Logic B+ (+5 VDC)

**2P9 - CABINET SOLENOIDS DRIVE**

1	Brown-Orange	Solenoid 11 Sound
2	Green-Violet	Solenoid 12 Sound
3	Brown-Green	Solenoid 13 Sound
4	Brown-Blue	Solenoid 14 Credit Klocker
5	Brown-Violet	Solenoid 15
6	Brown-Gray	Solenoid 16 Coin Lockout
7	Brown-Red	Solenoid 10 Sound
8	Key	Key
9	Brown-Black	Solenoid 9 Sound

**2P10 - SOLENOID GROUNDS**

1	Black	Solenoid Ground
2	Black	Solenoid Ground
3	Black	Solenoid Ground
4	Black	Solenoid Ground
5	Key	Key
6	N/C	Not Used
7	Black	Solenoid Ground
8	Black	Solenoid Ground
9	Black	Solenoid Ground

**2P11 - PLAYFIELD SOLENOIDS DRIVE**

1	Gray-Black	Solenoid 8
2	Gray-Violet	Solenoid 7
3	Gray-Blue	Solenoid 6
4	Gray-Brown	Solenoid 1
5	Gray-Red	Solenoid 2
6	Key	Key
7	Gray-Orange	Solenoid 3
8	Gray-Yellow	Solenoid 4
9	Gray-Green	Solenoid 5

**DRIVER BOARD (cont't)**

Pin	Wire Color	Function
<b>2P12 - SPECIAL SOLENOIDS DRIVE</b>		
1	Orange- Violet	Right Flipper Enable
2	Orange -Gray	Left Flipper Enable
3	Blue-Orange	Solenoid 19 (Special Solenoid 3)
4	Blue-Red	Solenoid 18 (Special Solenoid 2)
5	Key	Key
6	Blue-Yellow	Solenoid 20 (Special Solenoid 4)
7	Blue-Brown	Solenoid 17 (Special Solenoid 1)
8	Blue-Green	Solenoid 21 (Special Solenoid 5)
9	Blue-Black	Solenoid 22 (Special Solenoid 6)

**2P13 - SPECIAL SWITCH INPUTS**

1	Key	Key
2	Orange-Black	Special Switch 3
3	Orange-Red	Special Switch 2
4	Orange-Yellow	Special Switch 4
5	Orange-Brown	Special Switch 1
6	N/C	Not Used
7	N/C	Not Used
8	Orange-Green	Special Switch 5
9	Orange-Blue	Special Switch 6

**POWER SUPPLY****3P1 - POWER BUS INPUTS**

1	Violet	Lamps (+18 VDC)
2	Orange	Solenoids (+28 VDC)
3	N/C	Not Used
4	White	90 VAC
5	N/C	Not Used
6	N/C	Not Used
7	N/C	Not Used
8	N/C	Not Used
9	White	90 VAC
10	Gray	18.7 VAC
11	Gray	18.7 VAC
12	Gray-White	18.7 VAC C.T.

**3P2 - POWER BUS INPUTS**

1	N/C	Not Used
2	N/C	Not Used
3	Black	Solenoid Rect.
4	N/C	Not Used
5	N/C	Not Used
6	Black	Lamp Rect.

**3P3 - SOLENOID POWER BUS**

1	N/C	Not Used
*2	Black	Ground
3	Black	Ground (Spec. Switch Common)
4	Blue	Flipper B+ (+28 VDC)
5	Blue	Flipper B+ (+28 VDC)
6	Red	Solenoid B+ (+28 VDC)
7	Red	Solenoid B+ (+28 VDC)
*8	Red	+28 VDC
9	Key	Key

\*Connections provided at 3P3-2 and -8 only on games with solenoid-controlled lamps on Insert Board.



## POWER SUPPLY (con't)

Pin	Wire Color	Function
<b>3P4 - LAMP &amp; SOLENOID POWER BUS</b>		
1	Black	Ground
2	Black	Ground
3	Black	Ground
4	Black	Ground
5	Blue	Lamp B+ (+16 VDC)
6	Blue	Lamp B+ (+16 VDC)
7	Blue	Lamp B+ (+16 VDC)
8	Blue	Lamp B+ (+16 VDC)
9	Black	Ground
10	Black	Ground
11	Black	Ground
12	Black	Ground

**3P5 - DISPLAY POWER BUS**

1	Black	Ground
2	N/C	Not Used
3	Orange & Wht.-Blk	-100 VDC
4	Brown	+100 VDC
5	Key	Key
6	Gray	Logic B+ (+5 VDC)

**3P6 - LOGIC POWER BUS**

1	N/C	Not Used
2	N/C	Not Used
3	N/C	Not Used
4	N/C	Not Used
5	Key	Key
6	Gray-White	Logic B+ (+12 V Un-regulated)
7	Gray	Logic B+ (+5 VDC)
8	Gray	Logic B+ (+5 VDC)
9	Gray	Logic B+ (+5 VDC)
10	Gray	Logic B+ (+5 VDC)
11	Black	Ground
12	Black	Ground
13	Black	Ground
14	Black	Ground
15	Black	Ground

## MASTER DISPLAY

**4P1 - MASTER DISPLAY PLAYER #1**

1	Brown-Black	Units
2	Brown-Red	10's
3	Brown-Orange	100's
4	Brown-Yellow	1,000's
5	Brown-Green	10,000's
6	N/C	Key
7	Brown-Blue	100,000's
8	Brown	a
9	Red	b
10	Blue	f
11	Violet	g
12	Orange	c
13	Green	e
14	Yellow	d
15	White-Black	Cathode Keep Alive

## MASTER DISPLAY

Pin	Wire Color	Function
<b>4P2 - MASTER DISPLAY PLAYER #2</b>		
1	White-Black	Cathode Keep Alive
2	Red-Black	Units
3	Red-Brown	10's
4	Red-Orange	100's
5	Red-Yellow	1000's
6	Yellow	d
7	Green	e
8	Orange	c
9	N/C	Key
10	Violet	g
11	Blue	f
12	Red	b
13	Brown	a
14	Red-Green	10,000's
15	Red-Blue	100,000's

**4P3 - MASTER DISPLAY PLAYER #3**

1	White-Black	Cathode Keep Alive
2	Orange-Yellow	100's
3	Orange-Green	1000's
4	N/C	Key
5	Orange-Blue	10,000's
6	Orange-Violet	100,000's
8	Orange-Brown	Units
9	Brown	a
10	Red	b
11	Blue	f
12	Violet	g
13	Orange	c
14	Green	e
15	Yellow	d

**4P4 - MASTER DISPLAY PLAYER #4**

1	Yellow	d
2	Green	e
3	Orange	c
4	Violet	g
5	Blue	f
6	Red	b
7	Brown	a
8	Yellow-Brown	Units
9	Yellow-Red	10's
10	Yellow-Orange	100's
11	N/C	Key
12	Yellow-Green	1000's
13	Yellow-Blue	10,000's
14	Yellow-Violet	100,000's
15	White-Black	Cathode Keep Alive

## MASTER DISPLAY

### 4P5 - MASTER DISPLAY STROBE INPUTS

Pin	Wire Color	Function
1	N/C	Not Used
2	Brown-Gray	Strobe # 8
3	Brown-Violet	Strobe # 7
4	Violet-Gray	Strobe #16
5	Violet-Black	Strobe #15
6	Brown-Black	Strobe # 1
7	Brown-Red	Strobe # 2
8	Brown-Orange	Strobe # 3
9	Brown-Yellow	Strobe # 4
10	Brown-Green	Strobe # 5
11	Brown-Blue	Strobe # 6
12	Violet-Red	Strobe #10
13	Violet-Orange	Strobe #11
14	Violet-Blue	Strobe #14
15	Violet-Brown	Strobe # 9
16	Violet-Green	Strobe #13
17	Violet-Yellow	Strobe #12
18	N/C	Not Used

### 4P6 - MASTER DISPLAY BCD INPUTS

1	Blue-Red	B1
2	Blue-Orange	C1
3	Blue-White	Blanking
4	Blue-Yellow	D1
5	Blue-Brown	A1
6	Blue-Black	B2
7	Blue-Violet	C2
8	Blue-Gray	D2
9	Blue-Green	A2

### 4P7 - MASTER DISPLAY POWER INPUTS

1	White-Black	Keep Alive -100 VDC
2	Brown	+100 VDC
3	Gray	Logic B+ (+5 VDC)
4	N/C	Not Used
5	Black	Ground
6	Orange	-100 VDC

## PLAYER DISPLAYS

### 5P1 - PLAYER #1 SLAVE DISPLAY

1	Blue	f
2	Violet	g
3	Brown-Blue	100,000's
4	Green	e
5	Yellow	d
6	Brown-Green	10,000's
7	Brown-Yellow	1,000's
8	N/C	Not Used
9	Brown-White	Anode Keep Alive
10	White-Black	Cathode Keep Alive
11	Brown-Orange	100's
12	Brown-Red	10's
13	N/C	Key
14	Orange	c
15	Brown-Black	Units
16	Red	b
17	Brown	a
18	N/C	Not Used

## PLAYER DISPLAYS

### 5P2 - PLAYER #2 SLAVE DISPLAY

1	Blue	f
2	Violet	g
3	Red-Blue	100,000's
4	Green	e
5	Yellow	d
6	Red-Green	10,000's
7	Red-Yellow	1,000's
8	N/C	Not Used
9	Brown-White	Anode Keep Alive
10	White-Black	Cathode Keep Alive
11	Red-Orange	100's
12	Red-Brown	10's
13	N/C	Key
14	Orange	c
15	Red-Black	Units
16	Red	b
17	Brown	a
18	N/C	Not Used

### 5P3 - PLAYER #3 SLAVE DISPLAY

1	Blue	f
2	Violet	g
3	Orange-Violet	100,000's
4	Green	e
5	Yellow	d
6	Orange-Blue	10,000's
7	Orange-Green	1,000's
8	N/C	Not Used
9	Brown-White	Anode Keep Alive
10	White-Black	Cathode Keep Alive
11	Orange-Yellow	100's
12	Orange-Red	10's
13	N/C	Key
14	Orange	c
15	Orange-Brown	Units
16	Red	b
17	Brown	a
18	N/C	Not Used

### 5P4 - PLAYER #4 SLAVE DISPLAY

1	Blue	f
2	Violet	g
3	Yellow-Violet	100,000's
4	Green	e
5	Yellow	d
6	Yellow-Blue	10,000's
7	Yellow-Green	1,000's
8	N/C	Not Used
9	Brown-White	Anode Keep Alive
10	White-Black	Cathode Keep Alive
11	Yellow-Orange	100's
12	Yellow-Red	10's
13	N/C	Key
14	Orange	c
15	Yellow-Brown	Units
16	Red	b
17	Brown	a
18	N/C	Not Used

**BACK BOX MISCELLANEOUS**

Pin	Wire Color	Function
<b>6P1/6J1 - SWITCHED AC INPUT</b>		
1	White-Red	AC
2	White-Red	Jumper
3	White-Red	AC
4	White-Red	Jumper
5	White-Red	Jumper
6	White-Red	Jumper

**\*6P2/6J2 - SOLENOID 15**

1	Brown-Violet	Solenoid 15
---	--------------	-------------

**CABINET****7P1/7J1 - CABINET SOLENOIDS & SWITCHES**

1	Yellow	6.3 VAC Display Lamps
2	Yellow-White	6.3 VAC Display Lamps
3	Red	Solenoid B+
4	White	Diagnostic Common
5	Green	Diagnostic Advance
6	Blue	Diagnostic Auto/Man.
7	Orange-Violet	Right Flipper Enable
8	Blue-Violet	Right Flipper Switch
9	Orange-Gray	Left Flipper Enable
10	Blue-Gray	Left Flipper Switch
11-15	N/C	Not Used
16	Brown-Blue	Solenoid 14 (Knocker)
*17	Brown-Violet	Solenoid 15
18	Brown-Gray	Solenoid 16 (Coin Lockout)
19	Green-Brown	Switch Column #1
20	N/C	Not Used
21	White-Brown	Switch Row #1
22	White-Red	Switch Row #2
23	White-Orange	Switch Row #3
24	White-Yellow	Switch Row #4
25	White-Green	Switch Row #5
26	White-Blue	Switch Row #6
27	White-Violet	Switch Row #7
28	White-Gray	Switch Row #8
29	N/C	Not Used
**30	Black-Blue	Left (Dual Action) Flipper Switch
**31	Black-Yellow	Right (Dual Action) Flipper Switch
32	Black	Ground
33	Black-Brown	Audio
34	Black-Red	Memory Protect Interlock

\*On some games, Solenoid 15 may be a playfield solenoid or may drive Insert Board lamps. The Brown-Violet solenoid wire would then be connected to 6P2, 8P3, or 9P6.

\*\*Connected only on games with dual-action flippers.

**CABINET (con't)**

Pin	Wire Color	Function
<b>7P2/7J2 - COIN DOOR</b>		
1	Yellow	6.3 VAC Display Lamps
2	Yellow-White	6.3 VAC Display Lamps
3	Red	Coil B+
4	Brown-Gray	Solenoid 16 (Coin Lockout)
5	N/C	Not Used
6	Green-Brown	Switch Column #1
7	N/C	Not Used
8	White-Yellow	Switch Row #4
9	White-Green	Switch Row #5
10	White-Blue	Switch Row #6
11	White-Violet	Switch Row #7
12	White-Gray	Switch Row #8
13	White	Diagnostic Common
14	Green	Advance
15	Blue	Auto/Manual

**PLAYFIELD****\*8P1/8J1 - PLAYFIELD SWITCHES (White-15 Pin)**

1	Green-Red	Switch Column #2
2	Green-Orange	Switch Column #3
3	Green-Yellow	Switch Column #4
4	Green-Black	Switch Column #5
5	Green-Blue	Switch Column #6
6	Green-Violet	Switch Column #7
7	Green-Gray	Switch Column #8
8	White-Brown	Switch Row #1
9	White-Red	Switch Row #2
10	White-Orange	Switch Row #3
11	White-Yellow	Switch Row #4
12	White-Green	Switch Row #5
13	White-Blue	Switch Row #6
14	White-Violet	Switch Row #7
15	White-Gray	Switch Row #8

**8P2/8J2 - PLAYFIELD LAMPS  
(White-24 Pin)**

1	Yellow	6.3 VAC Display
2	Yellow-White	6.3 VAC Display
3	Yellow-Brown	Lamp Column #1
4	Yellow-Red	Lamp Column #2
5	Yellow-Orange	Lamp Column #3
6	Yellow-Black	Lamp Column #4
7	Yellow-Green	Lamp Column #5
8	Yellow-Blue	Lamp Column #6
9	Yellow-Violet	Lamp Column #7
10	N/C	Not Used
11	Red-Brown	Lamp Row #1
12	Red-Black	Lamp Row #2
13	Red-Orange	Lamp Row #3
14	Red-Yellow	Lamp Row #4
15	Red-Green	Lamp Row #5
16	Red-Blue	Lamp Row #6
17	Red-Violet	Lamp Row #7
18	Red-Gray	Lamp Row #8
19-22	N/C	Not Used
23	Blue	Flipper B+ (+28 VDC)
24	Blue	Flipper B+ (+28 VDC)

\*All switch columns are not always used.

**PLAYFIELD (con't)**

Pin	Wire Color	Function
<b>8P3/8J3 - PLAYFIELD SOLENOIDS, SPECIAL SWITCHES (Black) (24 Pin)</b>		
1	Red	Coil B+
2	Black	Ground (Special Switch Common)
3	Blue-Violet	Right Flipper Coil
4	Blue-Gray	Left Flipper Coil
5	Orange-Brown	Special Switch 1
6	Orange-Red	Special Switch 2
7	Orange-Black	Special Switch 3
8	Orange-Yellow	Special Switch 4
** 9	Orange-Green	Special Switch 5
10	Orange-Blue	Special Switch 6
11	Blue-Brown	Solenoid 17 (Special Sol. 1)
12	Blue-Red	Solenoid 18 (Special Sol. 2)
13	Blue-Orange	Solenoid 19 (Special Sol. 3)
*14	Blue-Yellow	Solenoid 20 (Special Sol. 4)
**15	Blue-Green	Solenoid 21 (Special Sol. 5)
16	Blue-Black	Solenoid 22 (Special Sol. 6)
17	Gray-Brown	Solenoid 1
18	Gray-Red	Solenoid 2
19	Gray-Orange	Solenoid 3
20	Gray-Yellow	Solenoid 4
21	Gray-Green	Solenoid 5
22	Gray-Blue	Solenoid 6
23	Gray-Violet	Solenoid 7
24	Gray-Black	Solenoid 8

**INSERT BOX****9P1/9J1 - INSERT DOOR LAMP CONNECTOR (Black-15 Pin)**

1	Yellow	6.3 VAC Display Lamps
2	Yellow-White	6.3 VAC Display Lamps
3	N/C	Not Used
4	Yellow	6.3 VAC Display Lamps
5	Yellow-White	6.3 VAC Display Lamps
6	Yellow-Violet	Lamp Column #7
7	Yellow-Gray	Lamp Column #8
8	Red-Brown	Lamp Row #1
9	Red-Black	Lamp Row #2
10	Red-Orange	Lamp Row #3
11	Red-Yellow	Lamp Row #4
12	Red-Green	Lamp Row #5
13	Red-Blue	Lamp Row #6
14	Red-Violet	Lamp Row #7
15	Red-Gray	Lamp Row #8

\*On some games Brown-Violet wire is connected to 8P3-4 for Solenoid 15 and Solenoid 20 is not used.

\*\*On games with dual-action flippers Black-Blue and Black-Yellow wires are connected to 8P3-9 and -15 for left and right flipper switches, respectively. On these games, Solenoid 21 is not used.

**INSERT BOX (con't)**

Pin	Wire Color	Function
<b>9P2/9J2 - PLAYER 1 KEEP ALIVE</b>		
1	Brown-White	Anode Keep Alive
<b>9P3/9J3 - PLAYER 2 KEEP ALIVE</b>		
1	Brown-White	Anode Keep Alive
<b>9P4/9J4 - PLAYER 3 KEEP ALIVE</b>		
1	Brown-White	Anode Keep Alive
<b>9P5/9J5 - PLAYER 4 KEEP ALIVE</b>		
1	Brown-White	Anode Keep Alive
<b>*9P6/9J6 - INSERT BOARD SOLENOID CONTROLLED LAMPS</b>		
1	Red	Solenoid B+ (+28 VDC)
2	Brown-Violet	Solenoid 15
3	Black	Ground

**SOUND BOARD****10P1 - POWER INPUTS**

1	Gray	18.7 VAC
2-4	N/C	Not Used
5	Gray-White	18.7 VAC C.T.
6	N/C	Not Used
7	Key	Key
8	N/C	Not Used
9	Gray	18.7 VAC

**10P2 - SPEAKER INPUT**

1	N/C	Not Used
2	Red	Speaker +
3	Black	Speaker Com
4	N/C	Not Used

**10P3 - SOUND SELECT INPUTS**

1	Key	Key
2	Brown-Red	Sound (10)
3	Brown-Black	Sound (9)
4	Brown-Yellow	Sound (12)
5	Brown-Orange	Sound (11)
6	N/C	Not Used
7	Brown-Green	Sound (13)
8	N/C	Not Used
9	N/C	Not Used

**10P4 - REMOTE VOLUME CONTROL**

1	Red	In
2	Black	Out
3	N/C	Key
4	Shield	Shield

**12P1/10J5 - SPEECH MODULE INTERCONNECT**

\*9P6 used only on games with solenoid controlled lamps on insert board.